



Workshop Manual



4 STROKE ENGINE

MX - EN - SMX
SMR - 2020

250-300

Foreword

This publication, to be used by TM Racing workshops, has been drawn-up to assist authorised personnel in the maintenance and repair of motorcycles handled. Perfect knowledge of the technical data stated herein is decisive for the most complete professional training of the operator.

In order to make it easier to understand, the paragraphs have been distinguished by schematic illustrations, which highlight the topic in question.

Always operate in compliance with the accident-prevention regulations in force, using suitable PPE.

COOLANT LIQUID

DANGER

FIRE RISK: IN SOME CONDITIONS, THE COOLANT IS FLAMMABLE. ITS FLAMES ARE INVISIBLE, BUT CAN CAUSE BURNS. DO NOT POUR COOLANT ONTO EXHAUST SYSTEM COMPONENTS OR ONTO ENGINE COMPONENTS, SINCE THEY COULD BE HOT AND IGNITE THE COOLANT, WITH THE RISK OF BURNS. KEEP IN MIND THAT THE FLAMES ARE INVISIBLE. COOLANT MAY IRRITATE THE SKIN AND IS TOXIC IF SWALLOWED. KEEP COOLANT OUT OF THE REACH OF CHILDREN. COOLANT IS HIGHLY POLLUTANT. THEREFORE, AFTER USE, IT MUST BE DISPOSED OF AT SPECIAL COLLECTION CENTRES IN COMPLIANCE WITH THE REGULATIONS IN FORCE IN THE COUNTRY IN WHICH THE MOTORCYCLE IS USED.

USED ENGINE OIL AND GEARBOX OIL

DANGER

KEEP OUT OF THE REACH OF CHILDREN. ENGINE OIL AND GEARBOX OIL CAN SERIOUSLY DAMAGE SKIN IF HANDLED REGULARLY OVER LONG PERIODS OF TIME. WASH YOUR HANDS THOROUGHLY AFTER HANDLING THE OIL. WEAR LATEX GLOVES OR EQUIVALENT DURING MAINTENANCE WORK ON THE MOTORCYCLE. OIL IS HIGHLY POLLUTANT. THEREFORE, AFTER USE, IT MUST BE DISPOSED OF AT SPECIAL COLLECTION CENTRES IN COMPLIANCE WITH THE REGULATIONS IN FORCE IN THE COUNTRY IN WHICH THE MOTORCYCLE IS USED. DO NOT POUR USED OIL INTO DRAINS OR RIVERS. DISPOSE OF FILTERS AT SPECIAL COLLECTION CENTRES IN COMPLIANCE WITH REGULATIONS IN FORCE IN THE COUNTRY IN WHICH THE MOTORCYCLE IS USED.

Useful advice

In order to prevent problems on reaching an excellent final result, **TM Racing** srl recommends that the following generic regulations are complied with:

- in the event of any repair, assess the impressions of the Customer reporting the operating anomalies of the motorcycle and formulate appropriate questions in order to clarify the symptoms of the problem;
- clearly diagnose the cause of the anomaly. From this manual it is possible to assimilate the essential theoretical bases, which, moreover, must be integrated by personal experience;
- plan the repair rationally, in order to prevent downtimes, receiving spare parts, preparation of tools etc.;
- reach the item to repair, limiting to the essential operations.

In this regard, consulting the disassembly sequence shown in this manual, will be of great help.

General repair-related regulations

- 1 Always replace the gaskets, sealing rings and the cotter pins with new parts.
- 2 When loosening/tightening nuts or screws, always start with the largest ones or from the centre. Lock at the coupling torque prescribed following a crosswise pathway.
- 3 Always mark all parts or positions that could be exchanged on re-mounting.
- 4 Use original spare parts and recommended lubricants.
- 5 Use special tools, where specified.
- 6 Consult official Technical Memos, since they could contain more updated state adjustment data and methods of intervention, with respect to this manual.

TM Racing SPA, declines all liability for any errors in the compilation of this manual, and reserves the right to make any modifications required for the development of its products. Illustrations shown are approximate and, in some cases, may not precisely correspond with the part referred to. Reproduction of this publication, even partial, without written authorisation is prohibited.

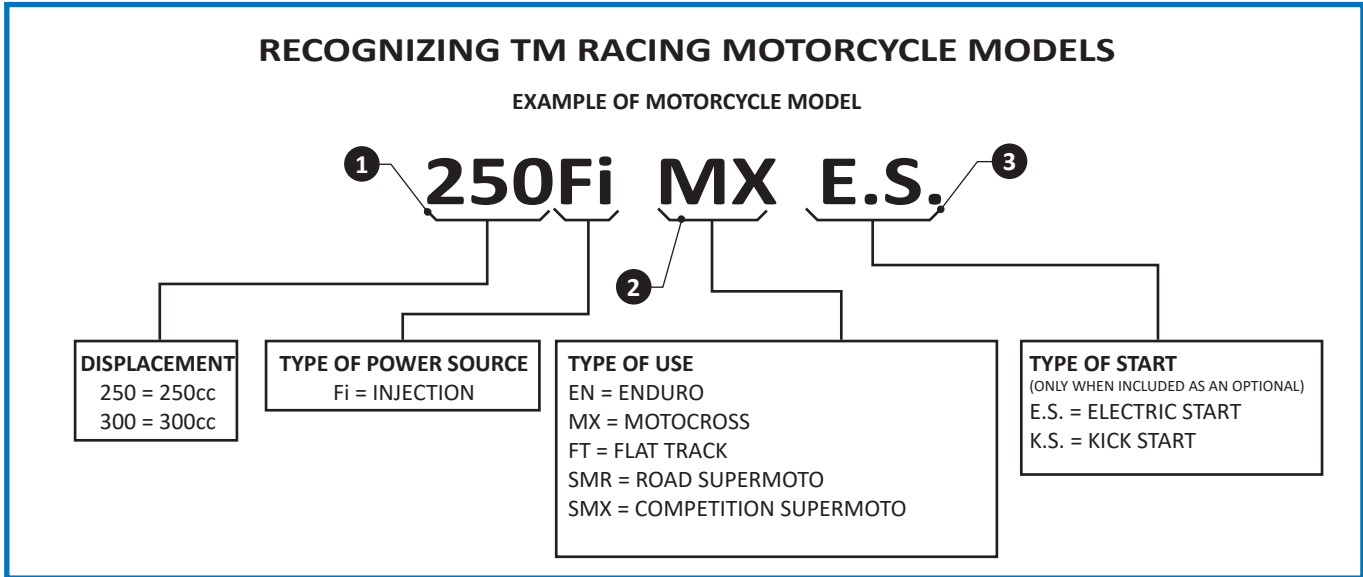

The displacement, type of power source and type of use define the motorcycle model and engine of each TM Racing motorcycle. The combination of codes 1 and 3 identifies the standard engine type. The combination of the three codes fully identifies the motorcycle model. All 3 codes are usually used in this Manual, to specify the motorcycle model to which certain information refers. If only codes 1 and 3 are indicated, followed by the word "ALL", it means that the information relates to all motorcycles with standard engine, regardless of the type of use. Code 2 (Type of Use) used alone means that the information refers to all motorcycles with that type of use, regardless of displacement and power source. All EN/SMR models are equipped as standard with electric start (E.S.) as well as kick start (K.S.). MX/SMX models have K.S. as standard and may be equipped with E.S. as an option.

Please make a note of your motorcycle's serial numbers in the boxes below. When it is necessary to contact TM for spare parts, updates or to report any issues, always quote the model, displacement, year of manufacture and, above all, the frame serial number and engine serial number.

ENGINE SERIAL NUMBER

The engine serial number (1) is embossed into the rear part of the engine, near to the shock absorber.

Make a note of this number in the relevant space at the beginning of the manual.

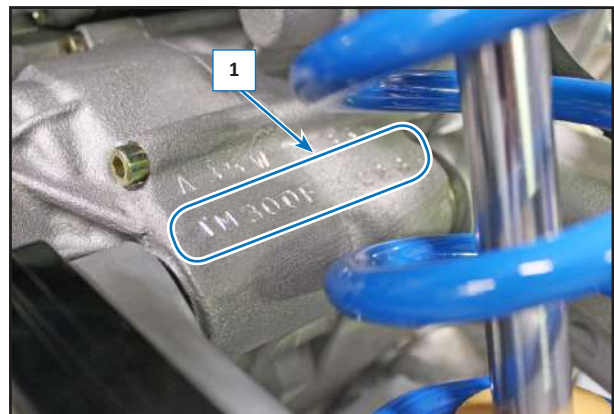

1.	ADJUSTMENTS/REPLACEMENTS	7
1.1	ADJUSTING VALVES PLAY (WITH COLD ENGINE)	8
1.1.1	Valve lifter spring replacement	11
1.2	CAMSHAFTS RE-MOUNTING	12
1.3	ENGINE OIL AND FILTER CHANGE	15
1.4	STANDARD CLUTCH REPLACEMENT	17
1.5	SLIPPER CLUTCH REPLACEMENT	19
1.5.1	Disc pack removal	19
1.5.2	Discs replacement and re-mounting of clutch	21
2.	ENGINE DISASSEMBLY.....	27
2.1	ENGINE COMPONENTS LAYOUT	28
2.2	PINION REMOVAL	29
2.3	CHAIN TENSIONER.....	30
2.3.1	Chain tensioner removal	30
2.3.2	Remounting the chain tensioner	32
2.4	HEAD	34
2.4.1	Head removal.....	34
2.4.2	Head dismantling	37
2.4.3	Head re-assembly	40
2.4.4	Head re-mounting	42
2.5	CYLINDER AND PISTON.....	45
2.5.1	Cylinder and piston removal	45
2.5.2	Strap and oil scraper replacement and mounting.....	46
2.5.3	Cylinder and piston coupling	46
2.5.4	Cylinder and piston re-mounting	46
2.5.5	Compression check	48
2.6	TEMPERATURE SENSOR REPLACEMENT	48
2.7	INTAKE MANIFOLD REPLACEMENT	48
2.8	HEAD EXHAUST MANIFOLD REPLACEMENT.....	49
2.9	HEAD COOLING CONNECTION REMOVAL.....	49
2.10	CLUTCH	50
2.10.1	Clutch actuator removal with relative command rod	50
2.10.2	Actuator dismantling	51
2.11	GEAR SENSOR.....	51
2.12	FLYWHEEL REMOVAL.....	52
2.12.1	Flywheel cover	52
2.12.2	Stator	53
2.12.3	Pick-up	53
2.12.4	Rotor	54
2.13	STARTER MOTOR.....	56
2.13.1	Disassembly	56
2.13.2	Re-mounting	58
2.14	WATER PUMP	59
2.15	TRANSMISSION GUARD	61
2.15.1	Bearing and water pump oil seal removal	62
2.15.2	Seal and oil passage bored disc removal.....	62
2.15.3	Kick start seal removal	62
2.15.4	Transmission cover re-assembly	63

2.16	IDLE KICK STARTER REMOVAL (ONLY K.S.)	64
2.16.1	Starter dismantling	64
2.16.2	Re-mounting	65
2.17	DRUM AND CLUTCH BELL.....	65
2.17.1	Disassembly	65
2.17.2	Re-mounting	67
2.18	TRANSMISSION SIDE COUNTER GEARS	69
2.19	CRANKSHAFT GEAR REMOVAL	70
2.20	OIL PUMP REMOVAL.....	71
2.21	GEARBOX COMMAND SHAFT REMOVAL	73
2.22	RATCHET-HOLDER GEAR REMOVAL.....	74
2.22.1	Ratchet holder gear and gearbox drive shaft clearance adjustment	75
2.23	SEMICASE	76
2.23.1	Aperture.....	76
2.23.2	RE-ASSEMBLY	77
2.24	CRANKSHAFT, GEARBOX, GEARS DRUM	77
2.24.1	Components position.....	77
2.24.2	Oil filter removal	77
2.24.3	Crankshaft removal	77
2.24.4	Gear shafts removal	78
2.24.5	Primary shaft, gear sequence	79
2.24.6	Secondary shaft, gear sequence	79
2.24.7	Ratchet removal.....	79
2.24.8	Bearings replacement	80
2.24.9	Components re-mounting.....	80

ENGINE TECHNICAL DATA 250Fi-300Fi EN EU4 250Fi-300Fi		
ENGINE MODEL	250	300
Type	4-stroke single cylinder twin cam, liquid-cooled	
Displacement	249 cm ³	291 cm ³
Bore x stroke	77x53.6 mm	81x56.5 mm
Compression	14: 1	13.7: 1
Fuel	RON 95 unleaded super fuel (ethanol allowed <10%)	
Distribution	4 overhead valve twin cam driven by silenced chain	
A / S camshafts	FA14 / FS4	FA4 / FS4
Suction valve diameter	32 mm Ti	
Exhaust valve diameter	26.8 mm Ti	
Cold suct. valve play	0.10 mm	
Cold exh. valve play	0.15 mm	
Engine shaft supports	1 ball + 1 roller bearing	
Connection rod bearing	Bushing	
Pin coating	DLC	
Piston	Forged light alloy	
Segments	1 segment + 1 oil scraper	
Lubrication	2 oil pumps (1 for delivery +1 for recovery)	
Engine oil	SAE 10W/50	
Engine oil amount (oil change/ engine overhaul)	1.25/1.35 litres	
Straight tooth gear primary transmission	18 / 59	20 / 59
Clutch	with multiple discs in oil bath	
Gearbox (with front couplings)	6 gears	
Gearbox ratios	(250)	(300)
1 st	14:30	13:31
2 nd	16:28	15:27
3 rd	20:29	16:23
4 th	22:27	20:24
5 th	24:25	20:21
6 th	20:19	22:20
Generator	12V 180W	
NGK spark plug	CR 9EIX	
Electrode distance	0.8 mm	
Cooling	fluid, 40% antifreeze, 60% water (up to -25°C) - forced circulation with pump	
Fluid amount	1 litre	
Start up	E.S. + K.S.	

Key:

E.S. = Electric Start

K.S. = Kick start

⚠ WARNING

TM reserves the right to make modifications to its products for technical improvements without prior notice.

MAINTENANCE TABLE

	After 1 hour	Every 15 hours	Every 30 hours (after every ride)	Every 45 hours	Every 135 hours (75 hours of sports use)	Every year
Change engine oil and cartridge oil filter	•	•	•			
Clean mesh oil filter					•	
Clean exhaust screw magnet		•	•			
Check engine fixing screw tightness	•	•	•			
Replace spark plug and cap check					•	
Check valve play			•			
Check distribution chain			•		•	
Replace distribution chain				•	•	
Check cylinder and piston wear				•	•	
Replace piston completely				•	•	
Check head				•	•	
Check camshafts and rocker arms					•	
Replace valves, springs, half cones and plates					•	
Replace piston rod completely					•	
Check clutch discs			•	•		
Check clutch springs				•		
Check transmission and gearbox					•	
Check oil pumps and lubrication circuit					•	
Replace engine bearings completely					•	
Replace engine oil seal completely					•	

⚠ WARNING

Components must be replaced if a defect is detected or wear limit values are exceeded at the check.
The afore-mentioned operations must be performed by an authorised TM workshop or by specialised personnel.

ENGINE

Problem	Cause	Solution	
The engine does not start or struggles to start	Insufficient compression		
	1. Piston seizing	Replace	
	2. Rod head or foot seizing	Replace	
	3. Worn piston segments	Replace	
	4. Worn cylinder	Replace	
	5. Insufficient cylinder head tightening	Tighten	
	6. Insufficient head gasket sealing	Replace	
	7. Spark plug loosened	Tighten	
	8. Incorrect valves play	Adjust	
	9. Valves springs weakened or seized	Replace	
	10. Valves seized	Replace	
		Spark weak or non-existent	
		1. Faulty spark plug	Replace
		2. Spark plug encrusted or wet	Clean or dry
		3. Excessive distance between spark plug electrodes	Adjust
		4. Apertures or short circuits in the high-voltage cables	Check
		5. Faulty ECU	Replace
	The engine stops easily	1. Spark plug encrusted	Clean
		2. Faulty ECU	Replace
		3. Low idle speed	Adjust
The engine is noisy	The noise seems to come from the piston		
	1. Excessive play between cylinder and piston	Replace	
	2. Segments or their housing in the piston worn	Replace	
	3. Excessive accumulation of carbon deposits in the combustion chamber or on the piston crown	Clean	
	4. Rocker arm worn	Replace	
	5. Excessive valves play.	Adjust	
	6. Valves springs weakened or seized	Replace	
	7. Distribution chain worn	Replace	
	8. Distribution chain tension not correct	Adjust	
		The noise seems to come from the crankshaft	
		1. Bench bearings worn	Replace
		2. Rod head radial or axial play high	Replace
		3. Crankshaft gear damaged	Replace
		4. Crankshaft fix. nut loosened	Tighten
		The noise seems to come from the clutch	
		1. Discs worn	Replace
		2. Excessive play between clutch bell and drive discs	Replace
		The noise seems to come from the gearbox	
		1. Gears worn	Replace
		2. Brake grooves consumed	Replace
	The clutch slips	1. Weakened clutch springs	Replace
		2. Clutch discs worn	Replace
	The clutch opposes resistance	1. Spring load not even	Replace
		2. Clutch discs bent	Replace
	The gears do not engage	1. Gearbox fork bent or seized	Replace
		2. Gear ratchets worn	Replace
		3. Forks command pins damaged	Replace
		4. Gears locking ratchet springs broken	Replace

Problem	Cause	Solution
The shift control pedal does not go back into position	1. Selector switch recall spring weakened or broken	Replace
	2. Gear forks worn	Replace
The gears disengage	1. Sliding gears couplings consumed	Replace
	2. Brake grooves worn	Replace
	3. Housings for couplings on the gears worn	Replace
	4. Grooves on the forks command shaft worn	Replace
	5. Forks command pins worn	Replace
INSUFFICIENT ENGINE POWER	1. Air filter dirty	Clean
	2. Low fuel quality	Replace
	3. Intake coupling loosened	Tighten
	4. Excessive distance between spark plug electrodes	Adjust
	5. Insufficient compression	Check the cause
	6. Incorrect valves play	Adjust
	7. Valve seats or guides faulty	Replace
	8. Valves springs weakened or seized	Replace
The engine overheats	1. Combustion chamber and/or piston crown encrusted with carbon residues	Clean
	2. Insufficient amount of oil in the engine or use of oil that is not recommended	Top-up or replace
	3. Obstructions to the air flow on the radiator	Clean
	4. Cylinder head gasket sealing faulty	Replace
	5. The clutch slips	Adjust or replace
ELECTRIC PART		
Problem	Cause	Solution
The spark plug electrodes overheat	1. Insufficient distance between electrodes	Adjust
	2. Heat rating too high	Replace with recommended spark plug
The starter motor does not start or slips	1. Faulty starter motor	Repair or replace
	2. Starter gears worn	Replace
	3. Free wheel rolls worn or damaged	Replace the free wheel



1. ADJUSTMENTS/REPLACEMENTS

1.1 ADJUSTING VALVES PLAY (WITH COLD ENGINE)

The valve play can be adjusted with the engine mounted on the vehicle or with engine on the bench.

NOTE: If the engine is mounted on the motorcycle, the airbox must be removed in order to access disassembly of the head cover.

For the sake of convenience, the images shown below refer to an engine positioned on a workbench.

Unscrew the screws (1) from the head cover (2).

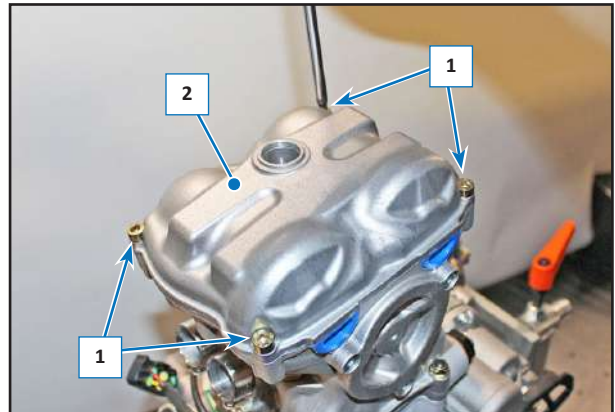

Remove the cover (2) using the corresponding gaskets (3) and (4). Check the status of the gaskets (3) and (4), replace them if worn.

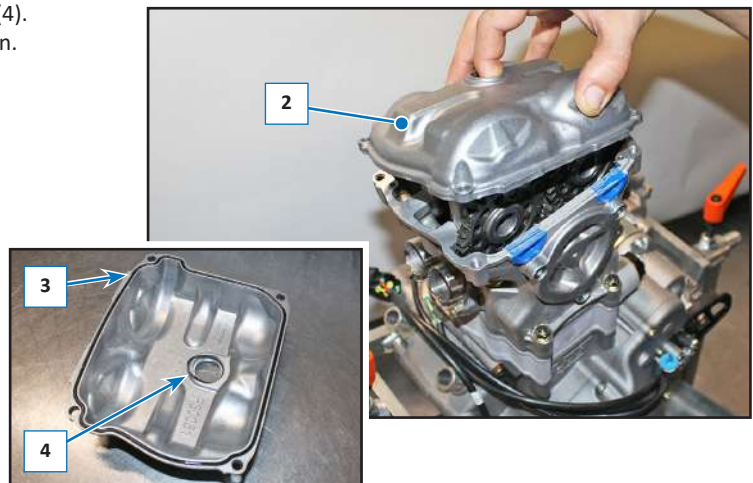

If it has not been removed yet, remove the spark plug (5) using a special wrench (6).

NOTE: The spark plug (5) is of the long thread type.

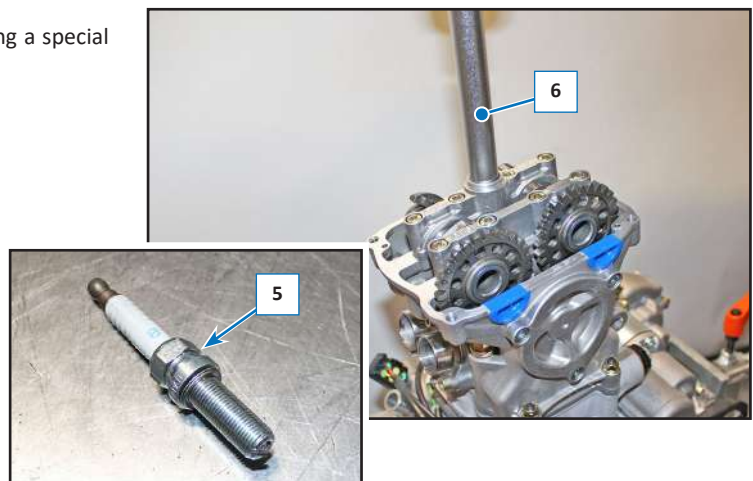

Mount a comparator (7) on the head.

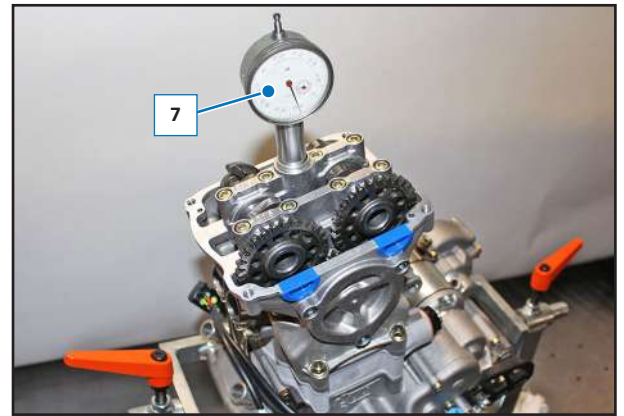

Remove the cap (8) from the generator cover (9).
Check the status of the gasket (10), replace it if worn.

Position the gearbox in neutral.

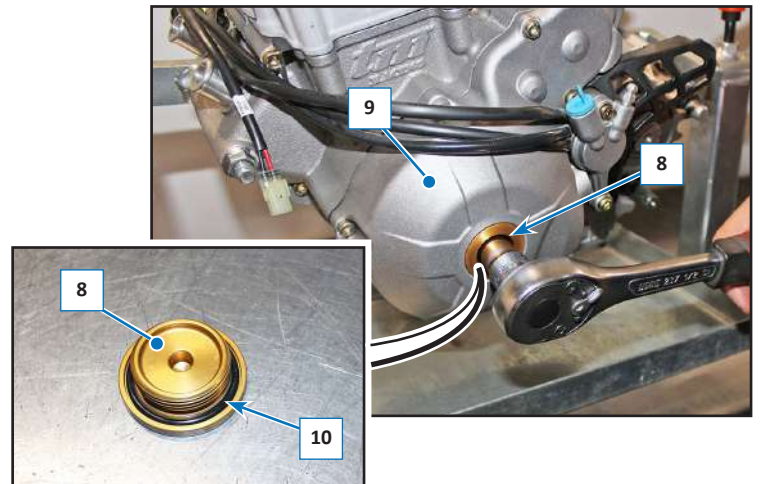

Using a socket wrench (11), turn the crankshaft to position the piston at top dead centre, as indicated by the timing points (12) parallel to the edge of the head present on the intake (13) and exhaust (14) camshaft gear.

Remove the comparator (7).

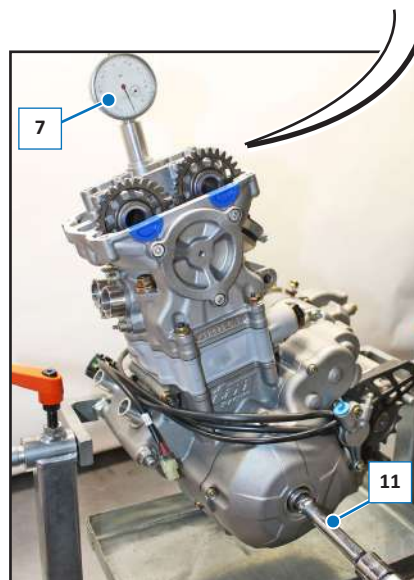
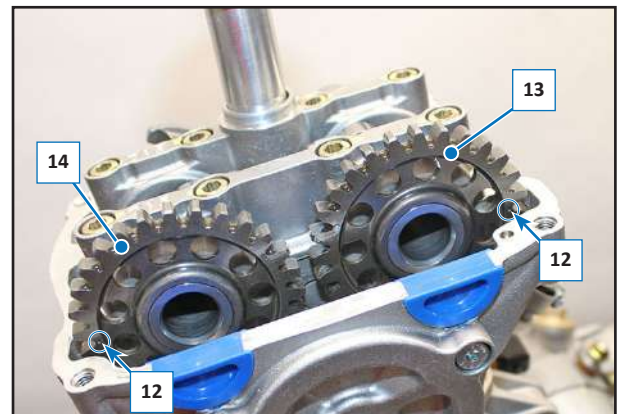

Use a thickness gauge (15) to check the play between the cams (16) of the intake camshaft (13) and the valve pad is 0.15mm (0.006 in.).

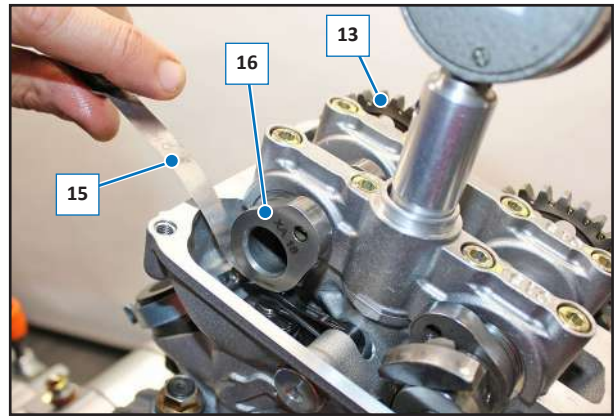

Use a thickness gauge (17) to check the play between the exhaust cams (18) of the intake camshaft (14) and the valve pad is 0.20 mm (0.008 in.).

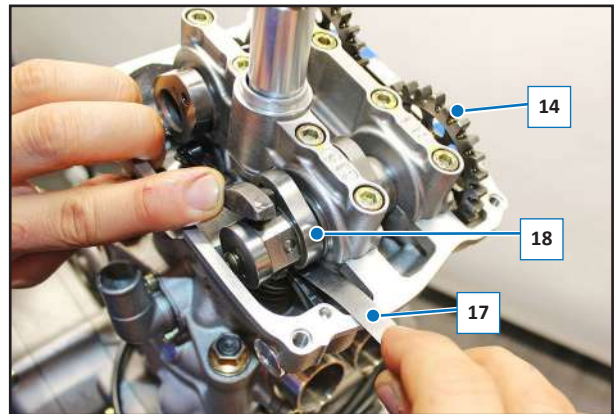

Otherwise the pads positioned on the valve stem head must be replaced, as follows:

Unscrew the screws (19) of the clamps (20) and (21).

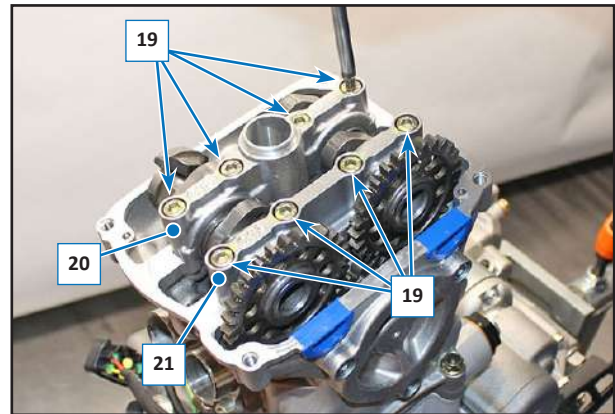

Remove the clamps (20) and (21).

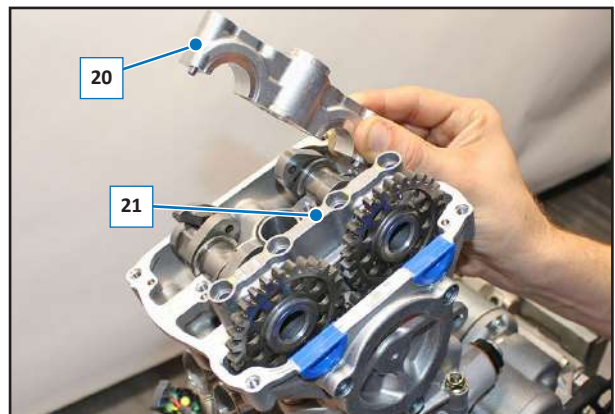

Remove the camshafts (13) and (14).

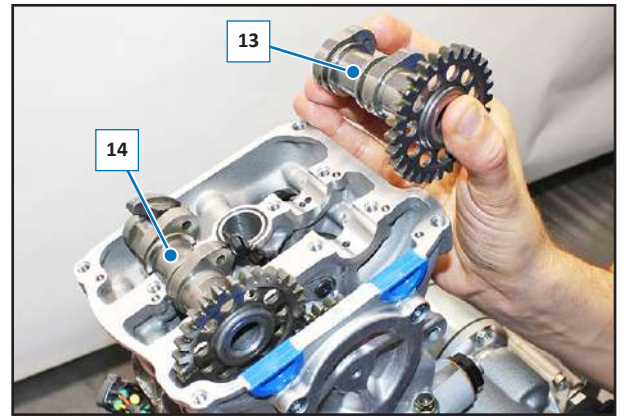

Lift the rockers (22) and remove the pads (23).

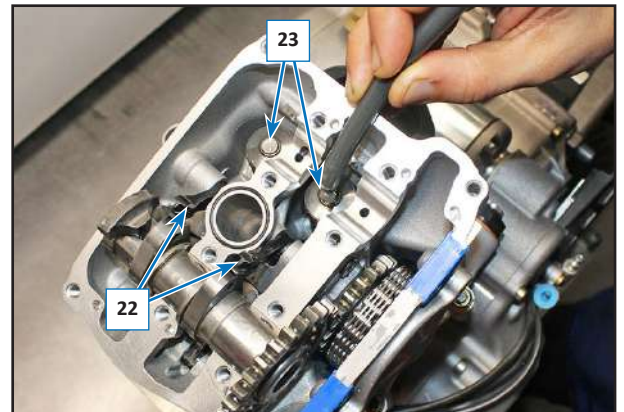

1.1.1 Valve lifter spring replacement

In case it is necessary to replace the spring of the valve lifter pin, work as follows:

- After dismounting the exhaust camshaft (1), unscrew the screw (2) and remove the plate (3).

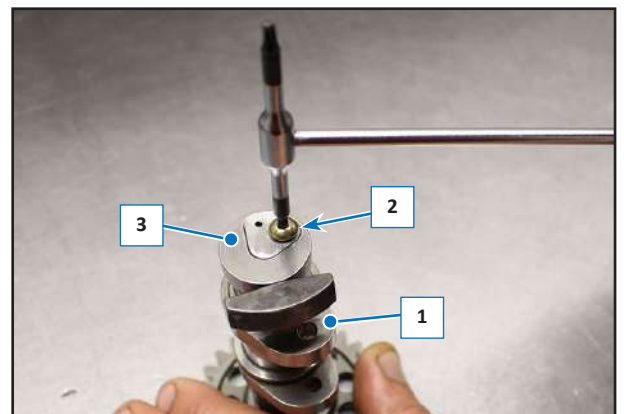

- Extract the spring (4) and the pin (5); check the status of the pin (5), replace if worn / ruined.
- Replace the spring (4) and remount all the components working in the opposite direction.

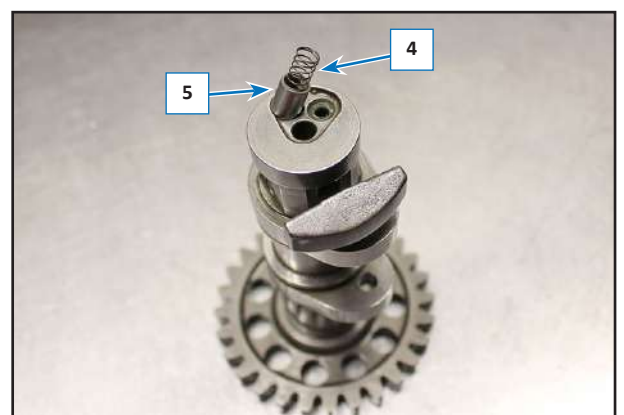

1.2 CAMSHAFTS RE-MOUNTING

Mount a comparator (1) on the head and position the piston at top dead centre, rotating the crankshaft via the closed-end spanner (2).



NOTE: Before remounting the camshafts, check that the gasket (3) is not worn, replace it if necessary.

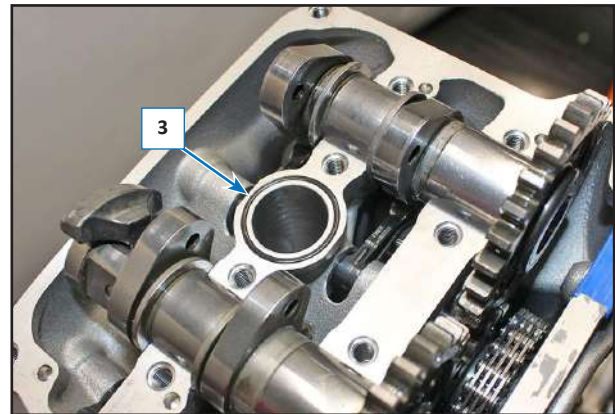

Mount the intake camshaft (4) and the exhaust camshaft (5) so that the tuning points (6) are parallel on the edge of the head.

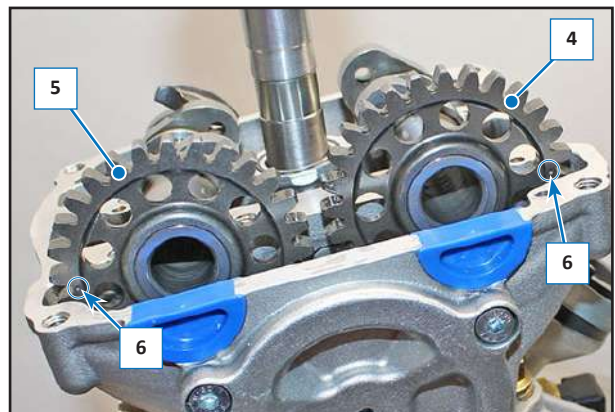

Mount the clamp (7) by inserting the centring pins in their corresponding seats.

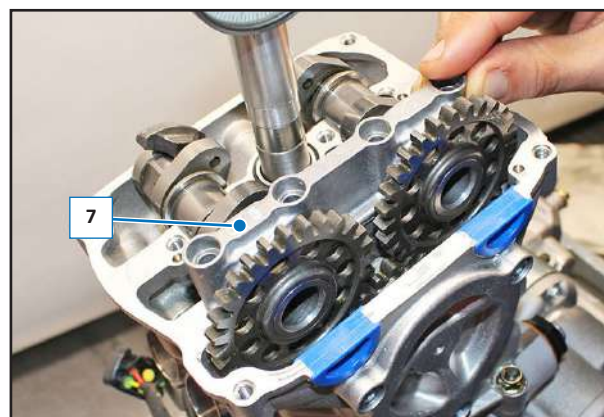

Remove the comparator (1).

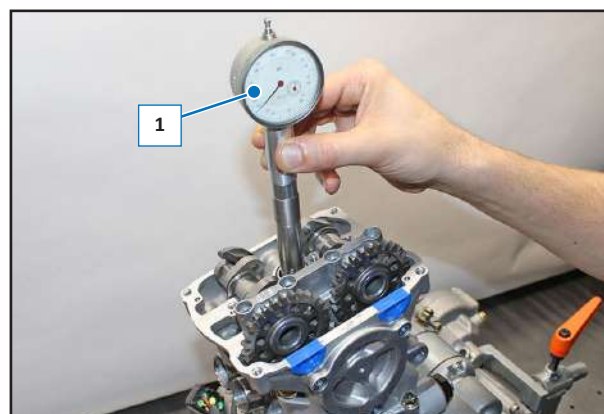

Mount the clamp (8) by inserting the centring pins in their corresponding seats.

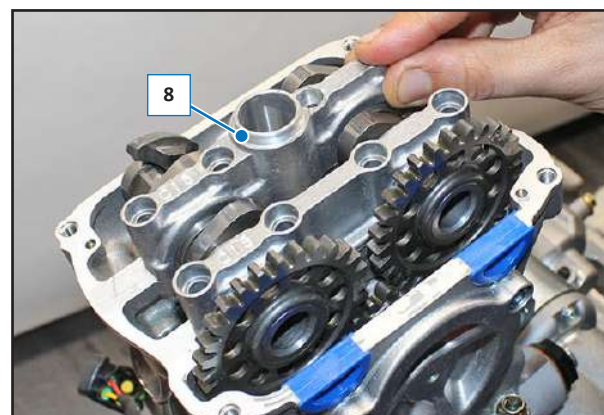

Screw the screws (9) alternately without tightening, then tighten the screws with a tightening torque of 10 Nm (1,0 kgm, 7,37 ft/lb).

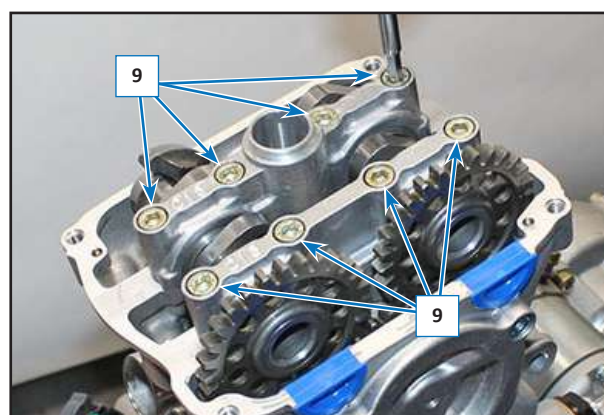

Check that valves play is correct (see “Valves play check” paragraph).

Spread some “Tree Bond 1215” sealing paste onto the surfaces of the two crescents (10).

Check that the gaskets (11) and (12), located on the head cover (13), are not worn. Replace them if necessary.

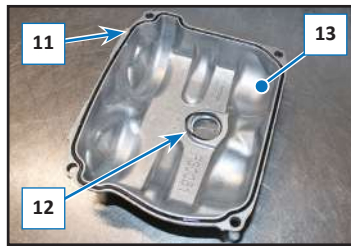
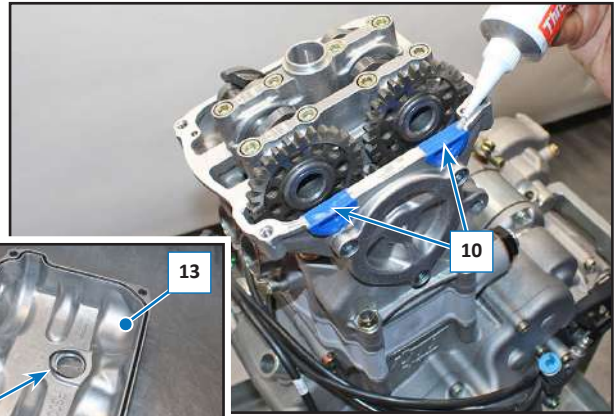

Mount the head cover (13) by screwing the screws (14) crosswise and then tightening them with a torque of 10 Nm (1 kgm/ 7.37 ft/lb).

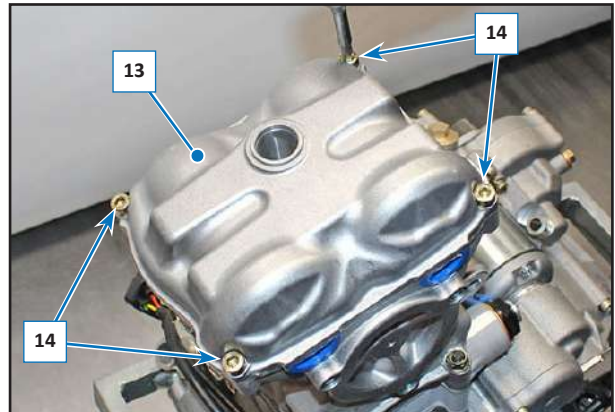

Mount the spark plug (15).

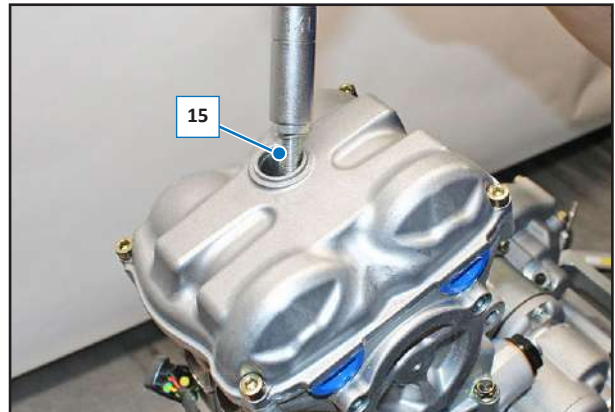

Check the gasket (16), replace it if worn, then remount the plug (17) screwing it with a tightening torque of 5 Nm (0,5 kgm, 3,69 ft/lb).

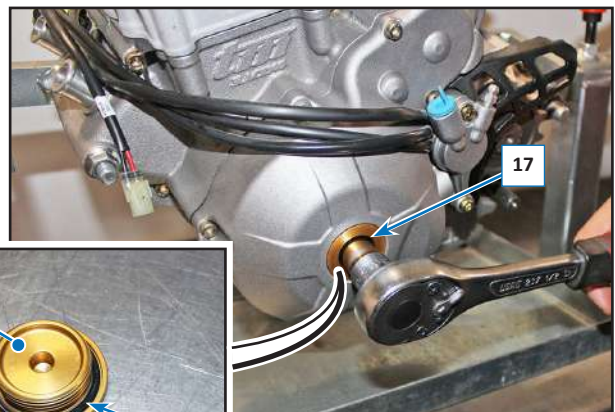

1.3 ENGINE OIL AND FILTER CHANGE

The oil must be changed with the engine off but still warm enough to allow the waste oil to flow out easily.

Unscrew the four screws (1) and remove the skid plate (2).

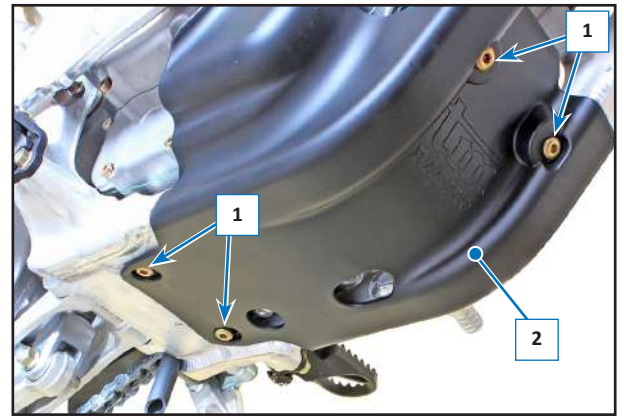

Position the motorcycle on a flat surface and prepare a suitable recipient under the same.

Loosen the introduction cap (3) positioned on the right side of the engine (clutch cover) and the drain caps (4 and 5) positioned on the lower side of the engine; allow the oil to flow out into the recipient.

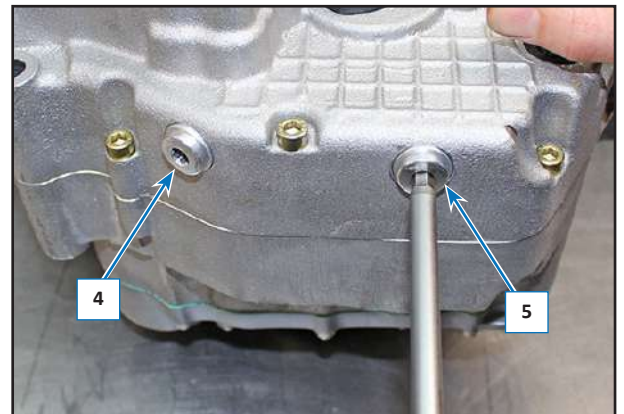
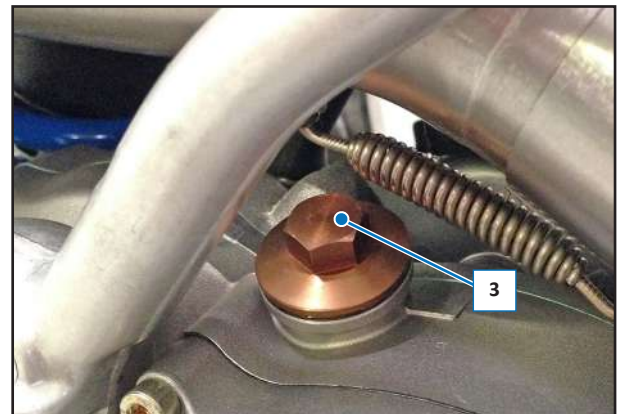

In the meantime, remove the filter cover (6) situated on the right side of the engine, loosening the relative screws (7) and paying attention to collect the oil escaping.

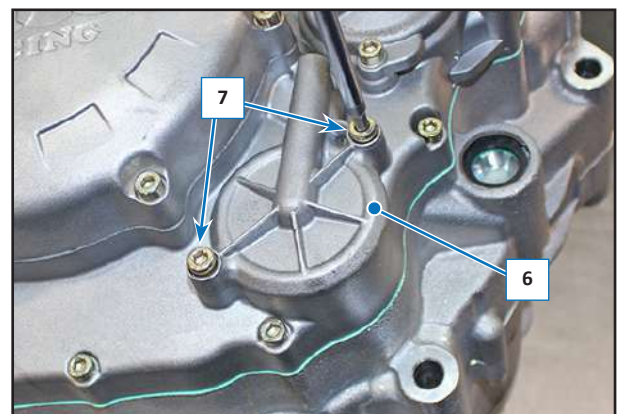

Extract the cartridge filter (8) and clean the surfaces of the guard and filter cover, check the seal O-rings (9 and 10) and replace them if necessary. Insert the original new TM Racing filter in a way to have the open side towards the outside of the engine. The filter must be inserted completely into its housing.

Re-mount the O-rings and the filter cover, tightening the screws (7) to 8 Nm (0.8 kgm, 5.9 ft/lb).

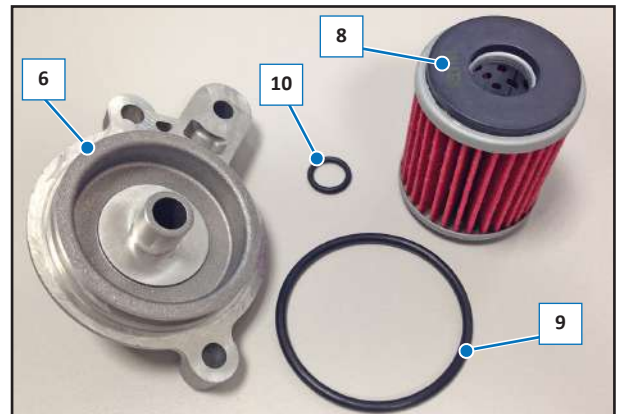
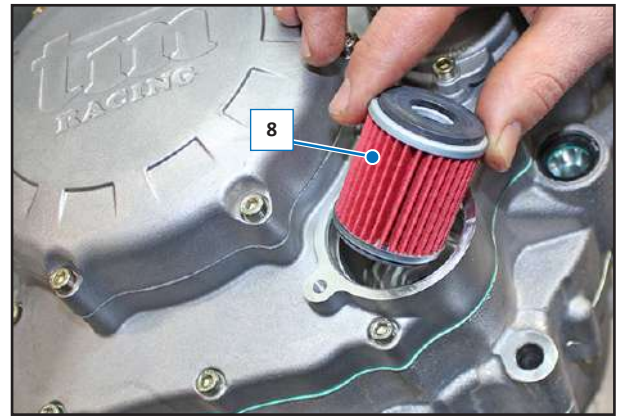

Wait for the oil to drain completely through the holes, clean the sealing surfaces, replace the aluminium washers, remove any magnetic debris (11) of the draining caps (4 and 5) and screw the caps back on, tightening to 20 Nm (2 kgm, 14,75 ft/lb).

Prepare a measure with the amount of the prescribed engine oil necessary (see table) and pour from the introduction hole.

Repeat the oil level check operation.

Check sealing of the filter cover introduction and drain caps.



⚠ DANGER

- PAY ATTENTION TO THE HOT OIL AND PARTS OF THE ENGINE; THERE IS A BURNS HAZARD.

⚠ WARNING

- A level that is too low, poor quality oil or maintenance intervals longer than those prescribed, cause serious damage to the engine. Do not introduce an excessive amount of oil into the engine. If this should happen, drain it as described previously.
- Always replace the filter when changing the oil. If there is no new filter, remove the one used to inspect it and drain the waste oil from the housing. Re-mount it according to the procedure described.
- Do not attempt to clean a used filter.

ENGINE OIL QUANTITY TABLE

Change oil and filter	1.25 l
Change oil and inspect filter	1.25 l
Engine overhaul.....	1.35 l

1.4 STANDARD CLUTCH REPLACEMENT

Drain the engine oil as described in the relative paragraph. Unscrew the M5-L65 (1) and M5-L25 (2) screws, then remove the clutch cover (3).

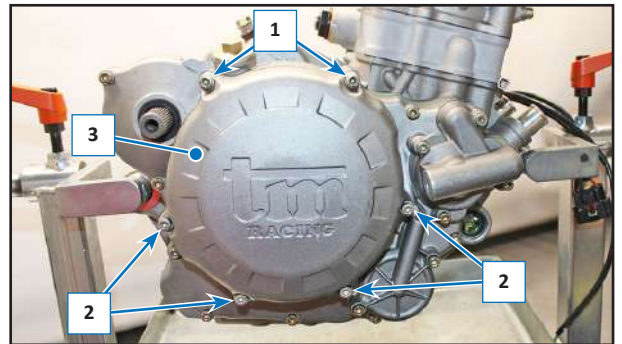

Remove the gasket (4).



Unscrew the screws (5) of the clutch pack.

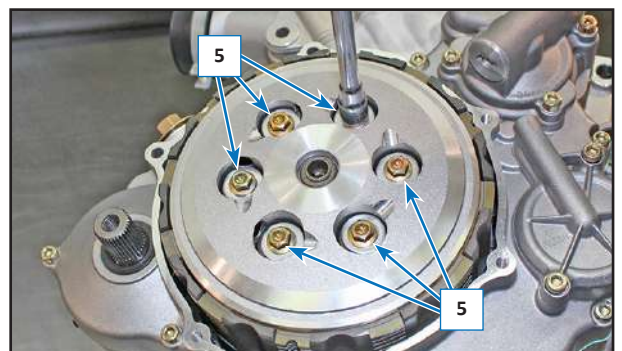

Remove the spring (6) and the pressure plate (7).

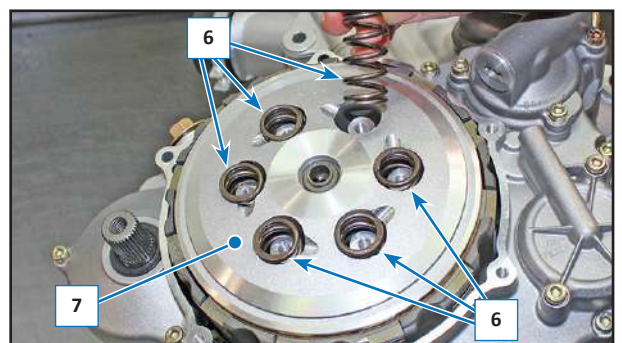

Remove the discs (8).



Check that the pressure plate (9) is present.

NOTE: On re-mounting the new discs, lubricate them with engine oil and make sure that the first disc mounted is lined, and that the first two smooth discs have thickness of 1.8 mm (the other discs have thickness of 1.5 mm).

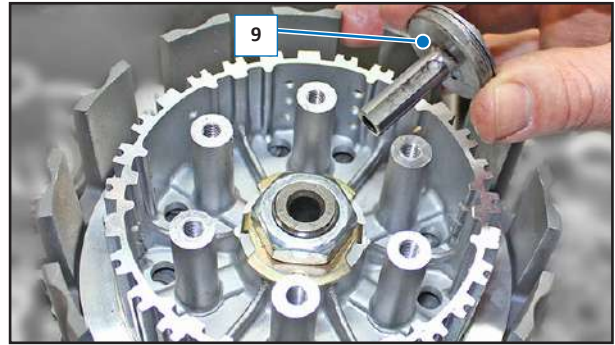

Remount the pressure plate (7) with the relative springs (6).

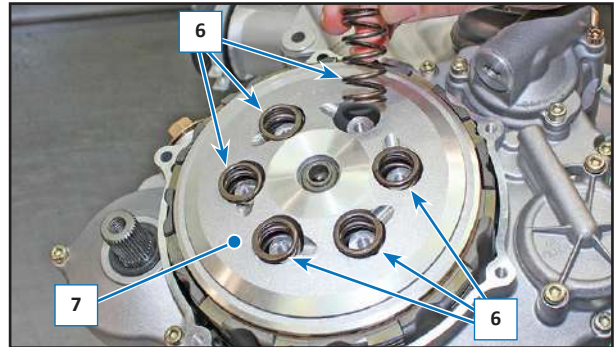

Re-mount the screws (5) and tighten them crosswise and gradually with a torque of 8 Nm (0.8 kgm/ 5.9 ft/lb).

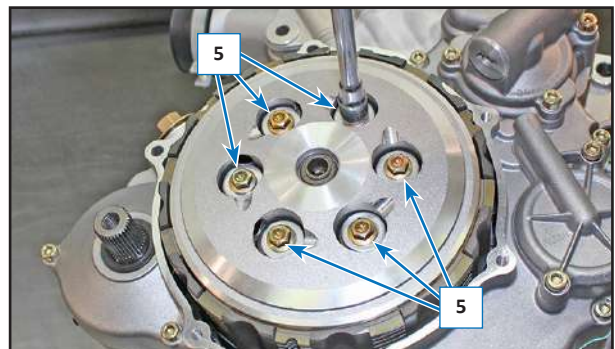

Check that the gasket (4) is not ruined, otherwise replace it.

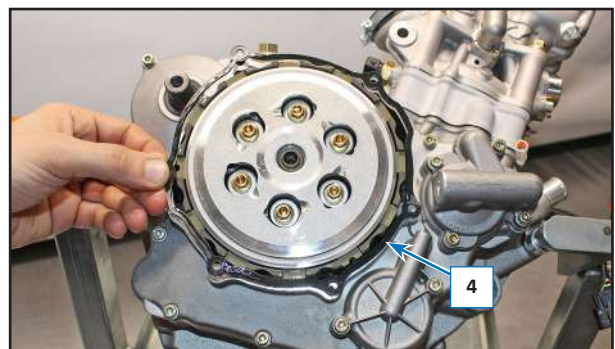

Mount the clutch guard (3) and tighten the screws (1) M5-L65 and (2) M5-L25 gradually with a torque of 8 Nm (0.8 kgm/ 5.9 ft/lb)

Introduce oil into the engine oil as described in the relative paragraph.

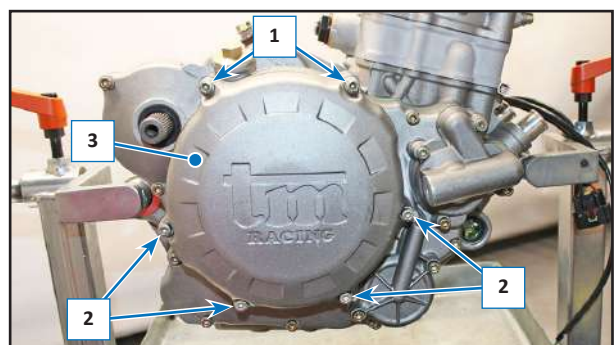

1.5 SLIPPER CLUTCH REPLACEMENT

1.5.1 Disc pack removal

Drain the engine oil as described in the relative paragraph. Unscrew the M5-L65 (1) and M5-L25 (2) screws, then remove the clutch cover (3) together with the corresponding gasket.

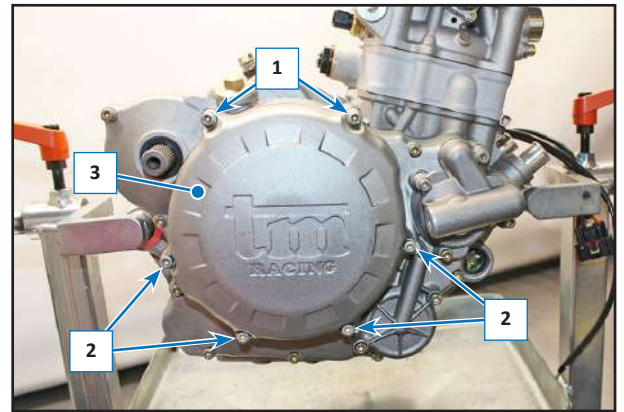

Tighten the columns (4) supplied.

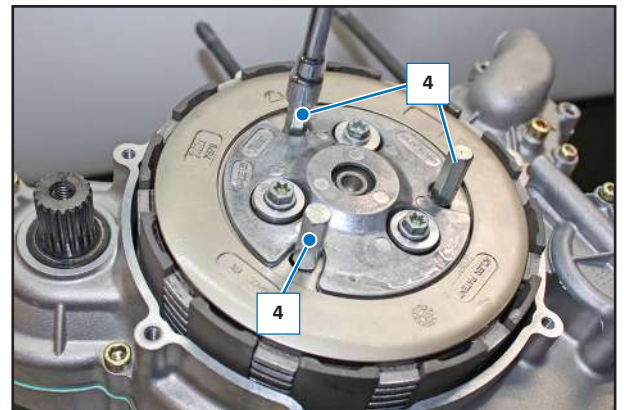

Loosen the screws (5) and remove the springs (6).

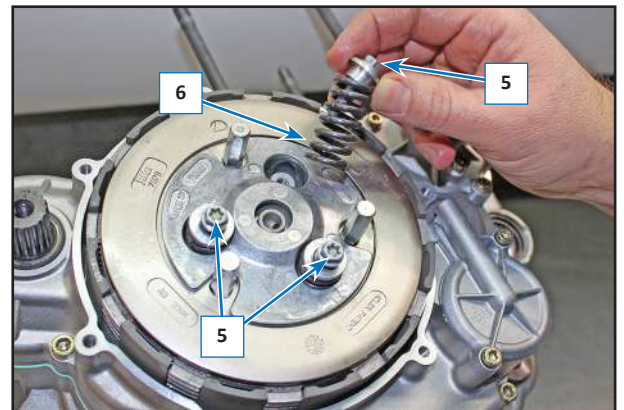

Remove the upper plate (7).

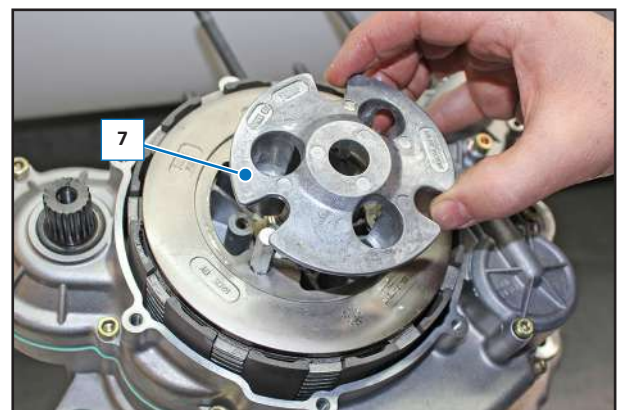

Remove the pressure plate (8).

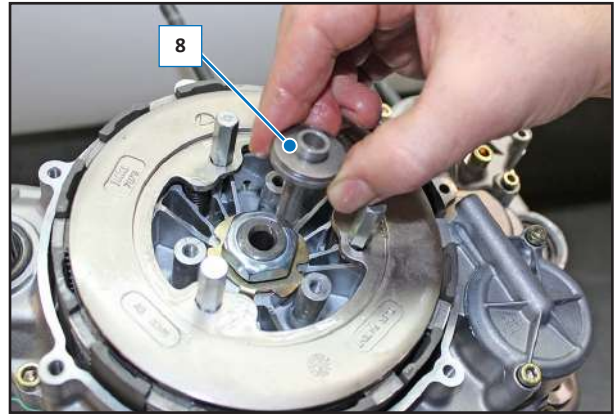

Unscrew the nut (9).

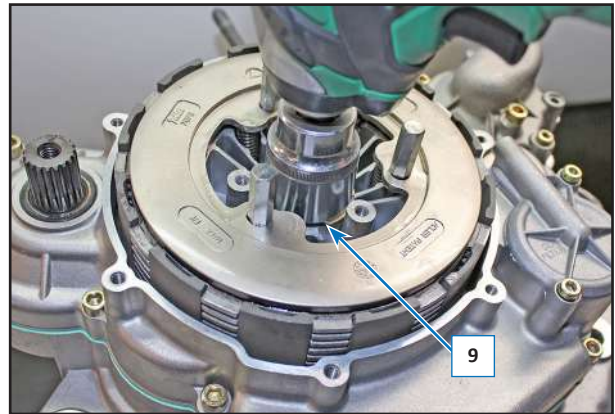

Remove the nut (9) and the washer (10).

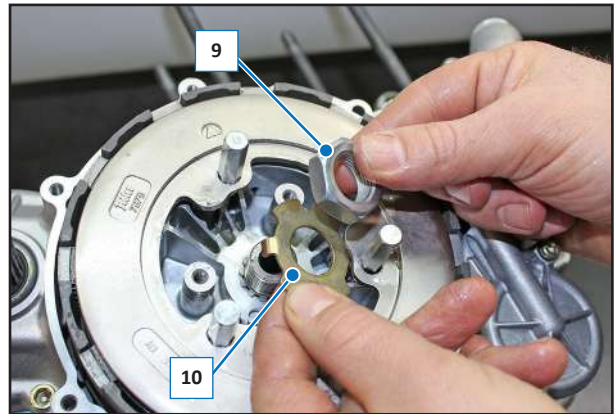

Remove the complete clutch pack (11).

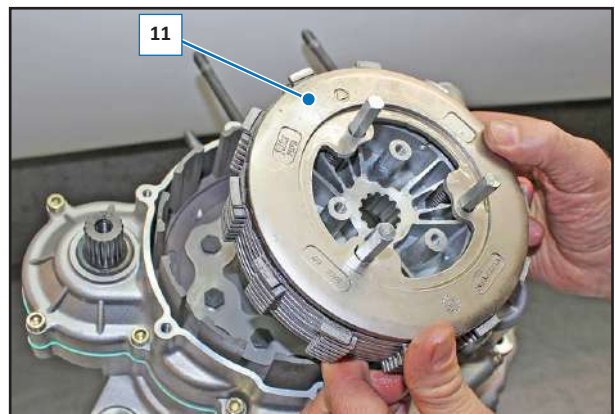

Unscrew the columns (4) and remove the upper drum (4a).

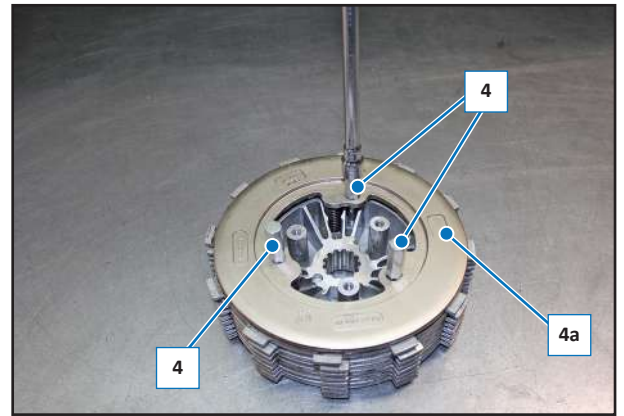

Extract the disk pack (12).

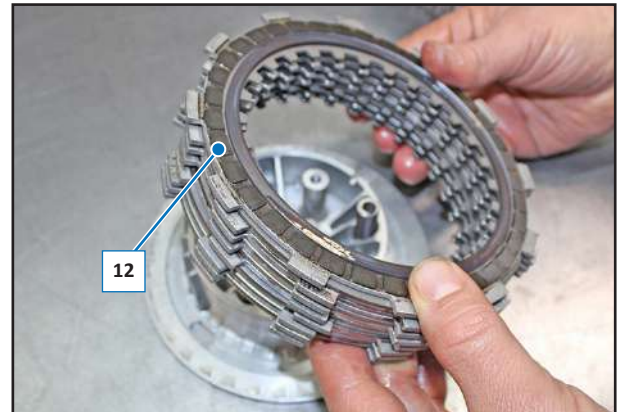

1.5.2 Discs replacement and re-mounting of clutch

Mark the position of the arrow (13) on the lower drum (14), which must coincide with the position of the arrow embossed on the upper drum of the clutch pack.

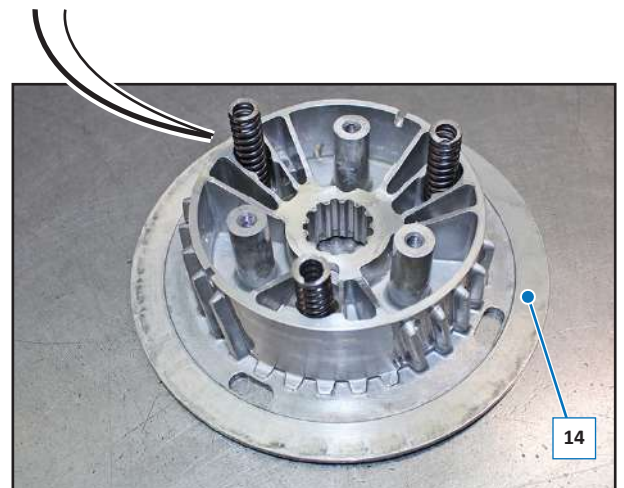

NOTE: On re-mounting the new discs, lubricate them with engine oil and make sure that the first disc mounted is lined, and that the first two smooth discs have thickness of 1.5 mm (the other discs have thickness of 2 mm).

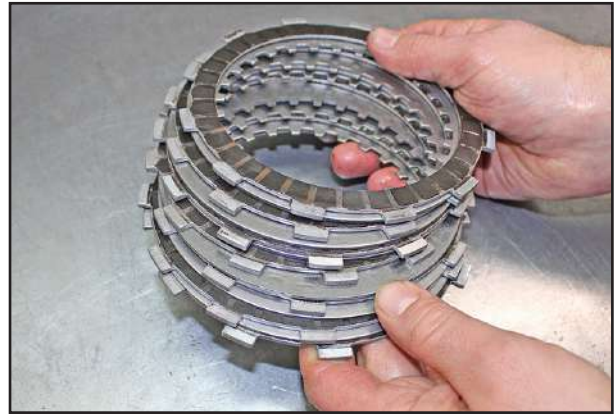

The clutch pack must finish with a smooth disc.

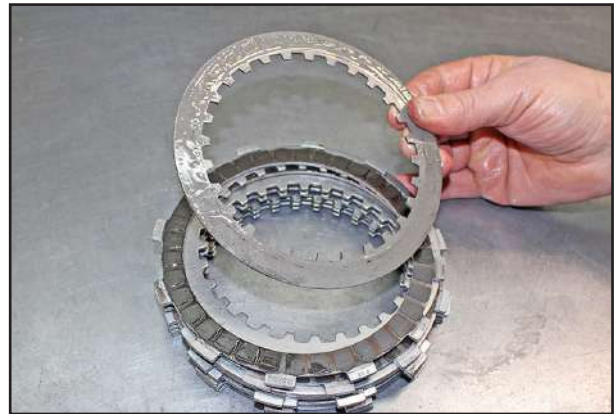

Mount the lined disc (15) with smaller lining than the others.

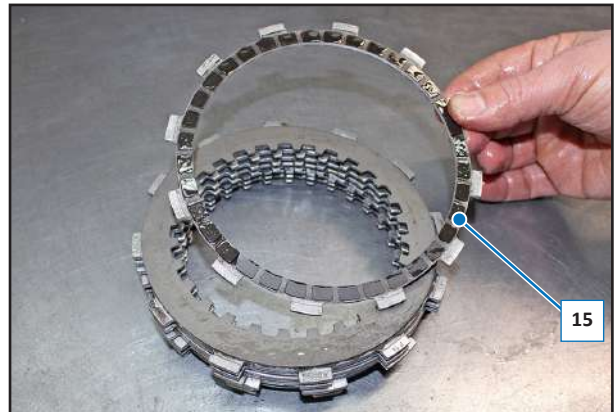

Mount the washer (16) and the Belleville washer (17), which are not supplied with disc spare parts; therefore those present must be re-used.

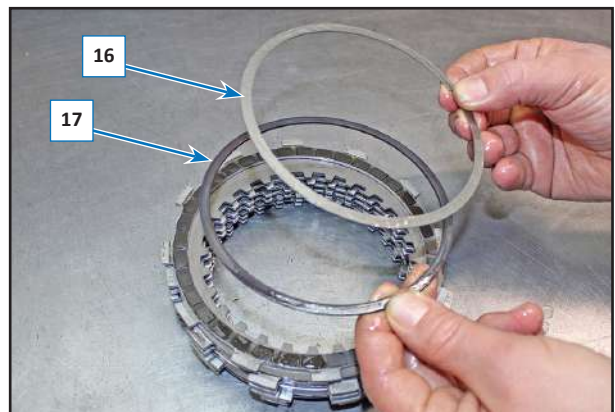

Mount the disk pack (18) on the lower drum (14).

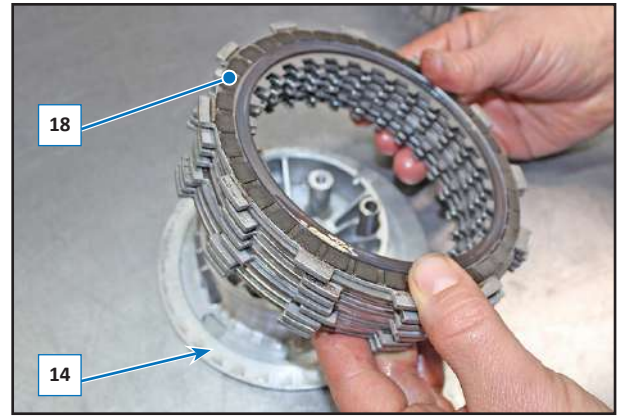

Mount the upper drum (4a), making the arrow (19) coincide with arrow (13) of the lower drum and then tighten the columns (4).

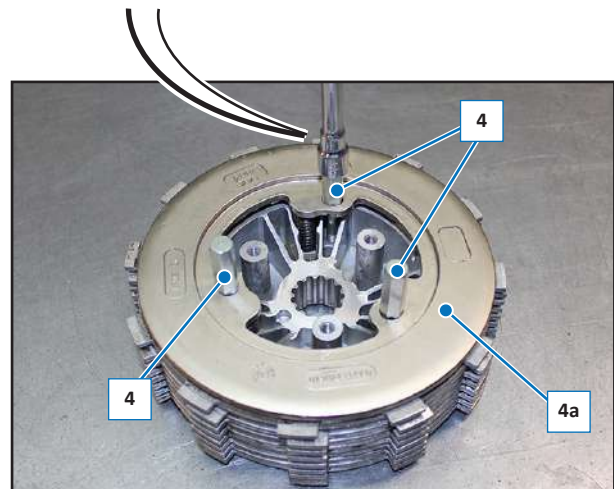
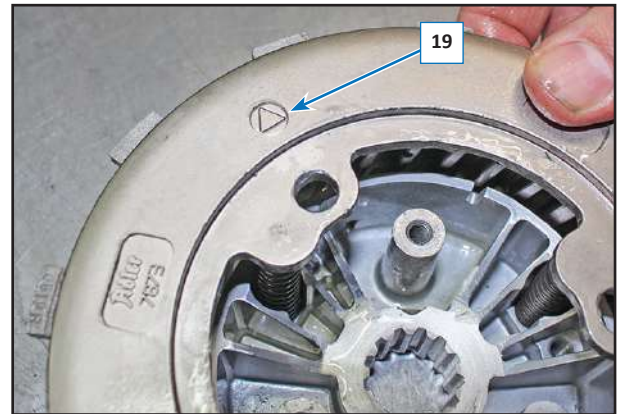

Mount the clutch pack (11).



Insert the safety washer (10) and the nut (9).

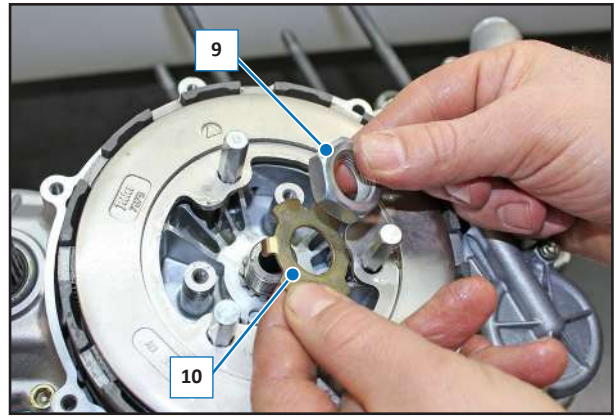

Tighten the nut (9) with a torque of 100 Nm/ 10 kgm/ 73.75 ft/lb + Loxeal 82-33.

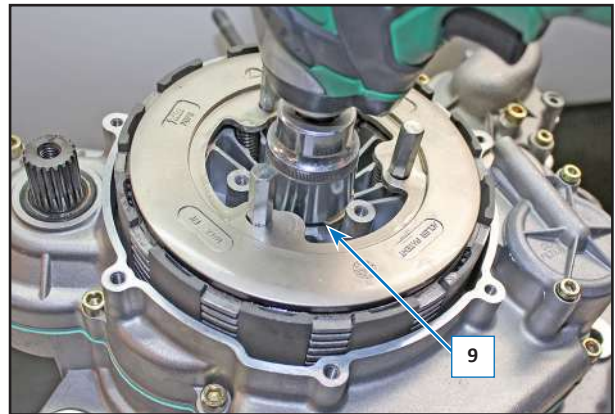

Lock the nut by raising the tabs of the lock washer (10).

Mount the pressure plate (8).

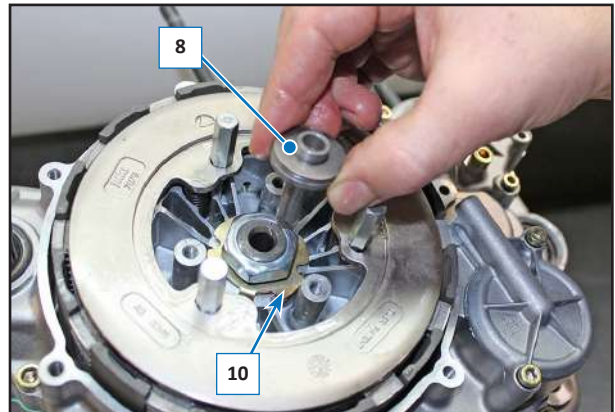

Mount the upper plate (7).

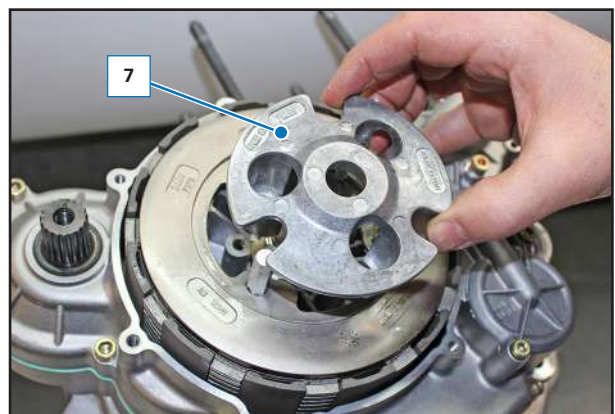

Mount the screw (5) with the relative springs (6) and bushes (20).

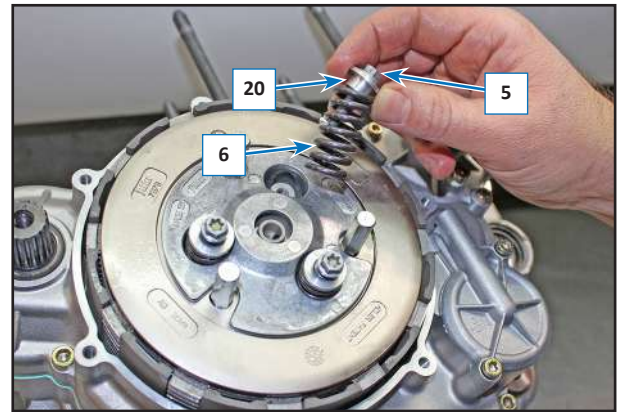

Tighten the screws (5) with a torque of 8 Nm (0.8 kgm/ 5.9 ft/lb).

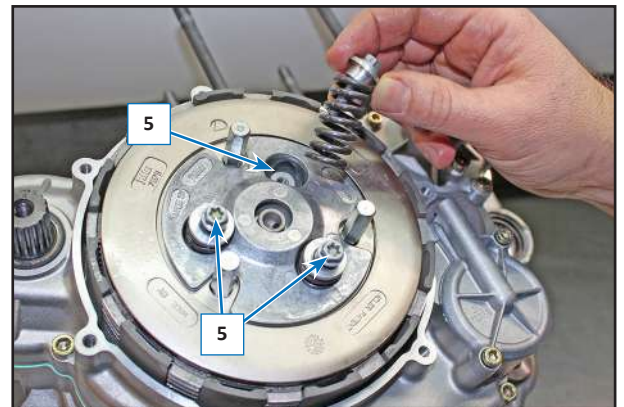

Remove the columns (4) supplied.

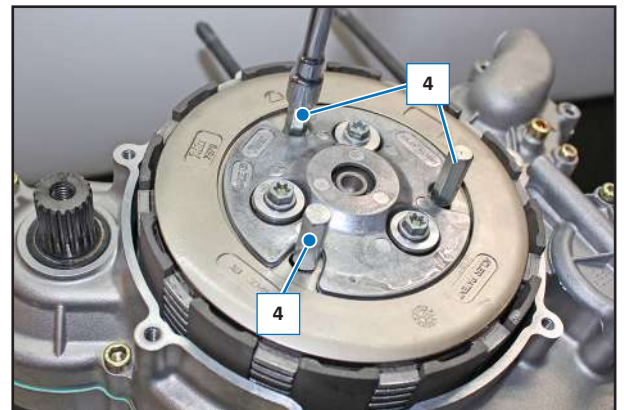

Mount the clutch guard (3) and relative gasket, replace it if worn, and tighten the screws (1) ML-L65 and (2) ML-L25 gradually with a torque of 8 Nm (0.8 kgm/ 5.9 ft/lb).

Introduce oil into the engine oil as described in the relative paragraph.

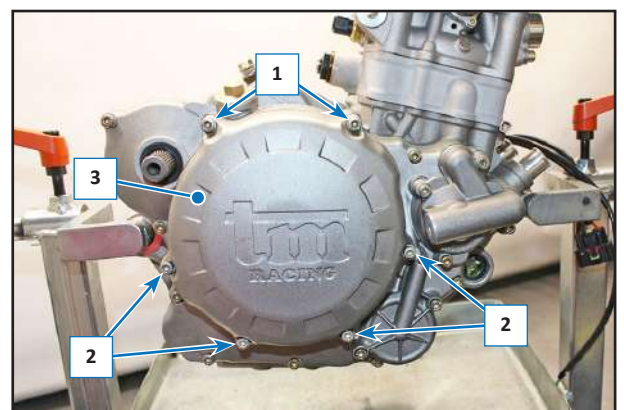





2. ENGINE DISASSEMBLY

2.1 ENGINE COMPONENTS LAYOUT

- 1 Cylinder head cover
- 2 Cylinder head
- 3 Chain tensioner
- 4 Cylinder
- 5 Starter motor
- 6 Throttle body connection coupling
- 7 Temperature sensor
- 8 Transmission cover
- 9 Oil filter
- 10 Water pump
- 11 Ignition cover
- 12 Gear sensor
- 13 Clutch actuator
- 14 Sprocket

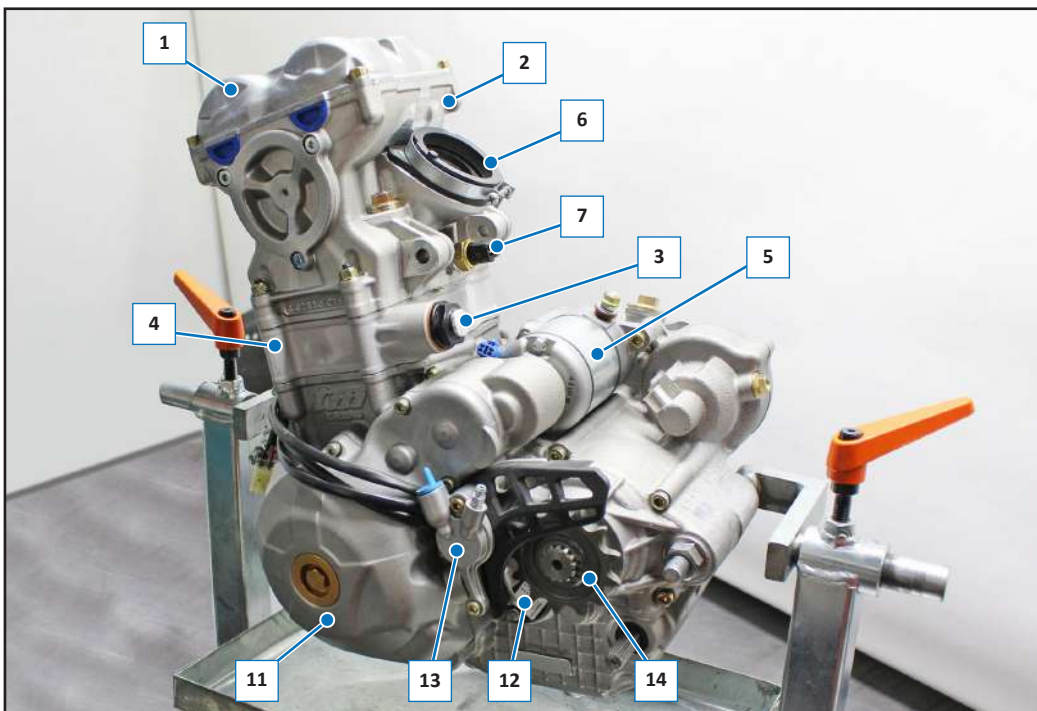
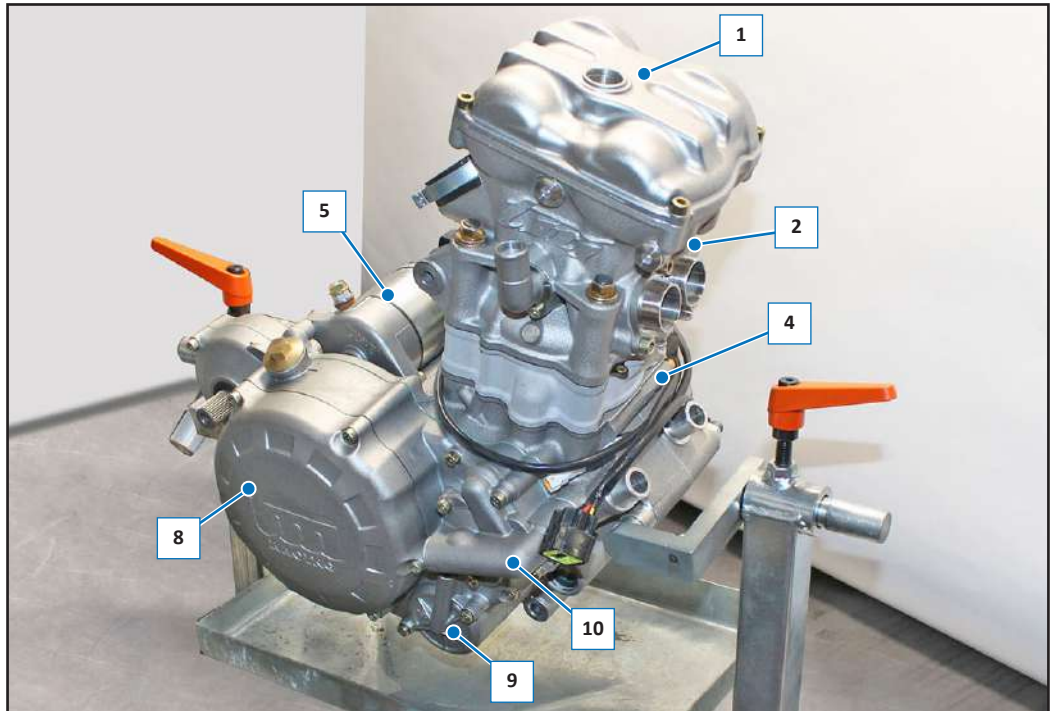

2.2 PINION REMOVAL

Remove the clutch actuator with the pinion cover casing, as described in the relative paragraph.

Remove the seeger ring (1) and the pinion (2).

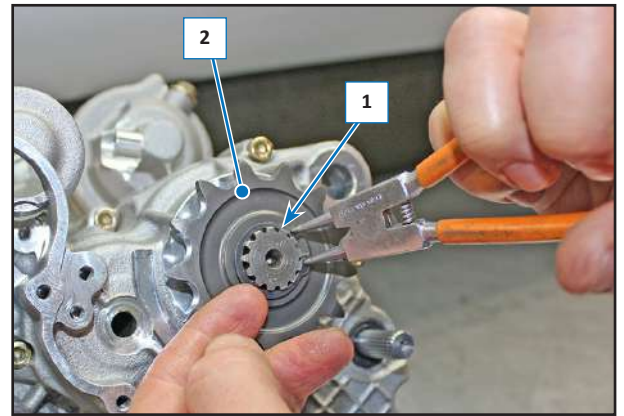

Slide the bushing (3) out.

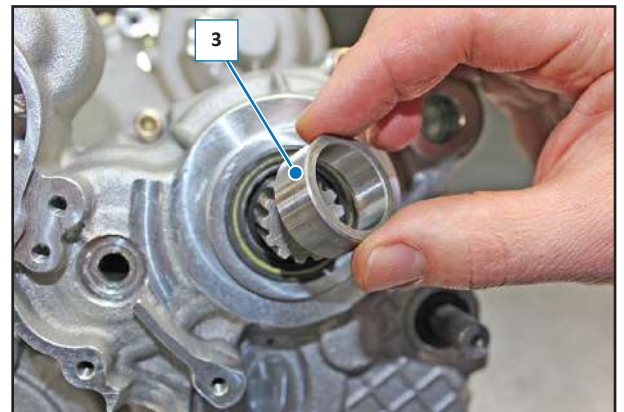

NOTE: On re-mounting the bush (3), check the status of the O-ring gasket (4) and replace it if worn. Lubricate the bush (3) and the gasket (4) with engine oil before remounting it.

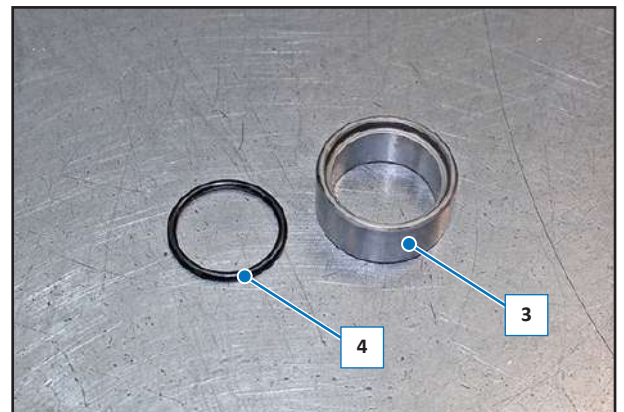

2.3 CHAIN TENSIONER

2.3.1 Chain tensioner removal

Unscrew the plug (1) and remove it.
Remove the gasket (2) and replace it remounting it on the plug (1).

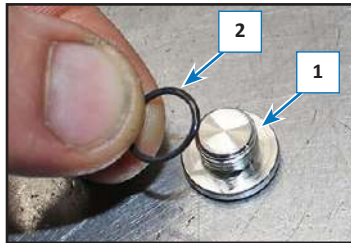
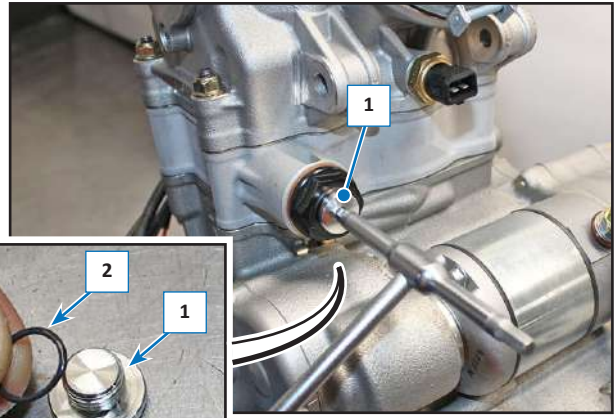

Unscrew the chain tensioner plug (3) and remove it.
Remove the copper washer (4), replace it and remount it on the plug (3).

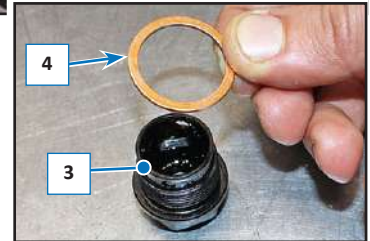
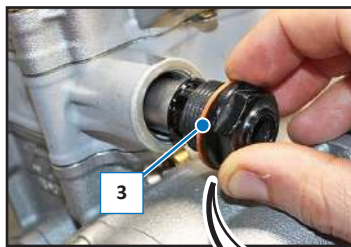
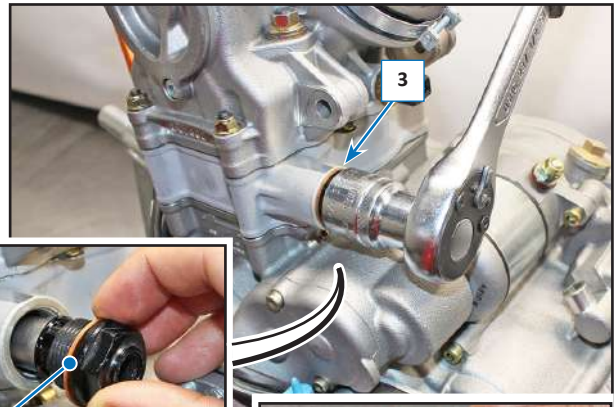

Remove the chain tensioner (5).

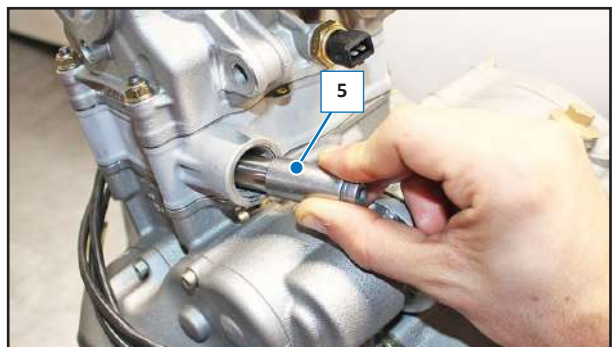

Remove the OR gasket (6).

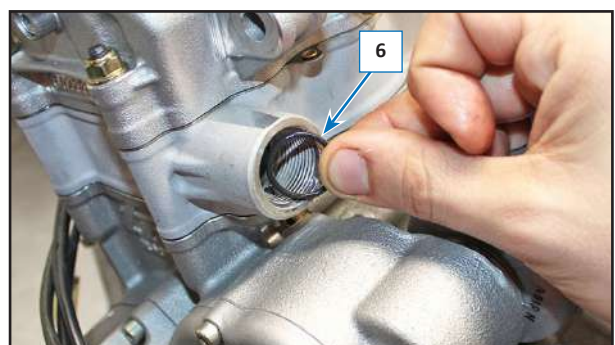

Place the chain tensioner (5) between the aluminium clamps (7) of a vice.

Tighten the vice until end of stroke, making the oil located inside the chain tensioner (5) come out.

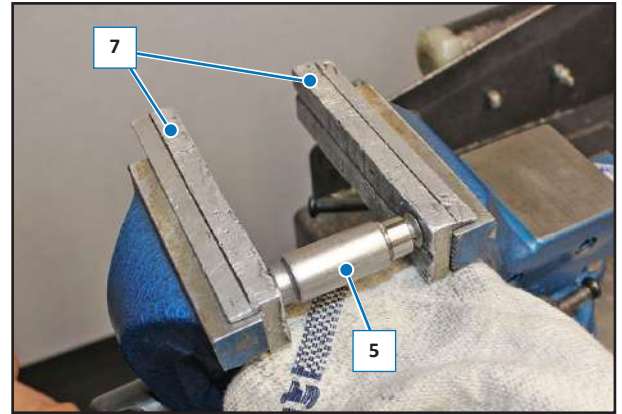

Remove the chain tensioner (5) from the vice and press it manually until end of stroke, checking that it slides without obstacles.

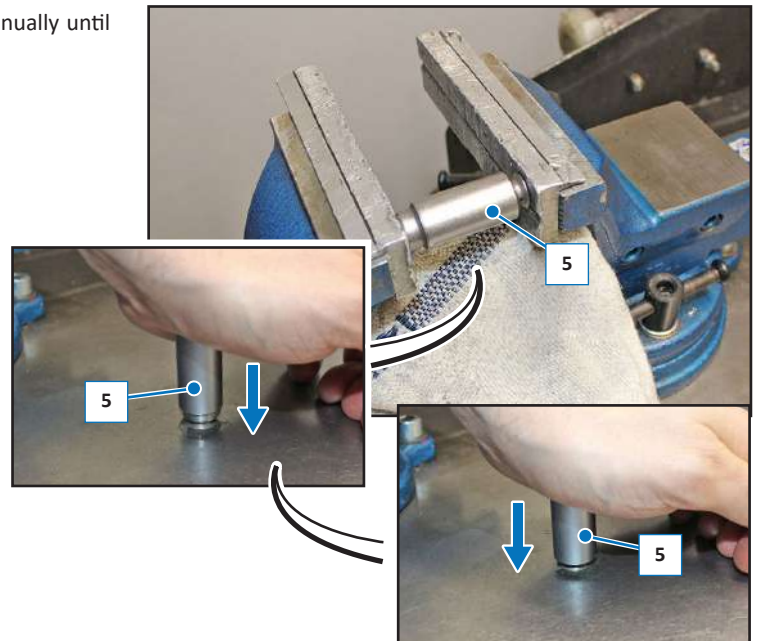

Further press the chain tensioner (5) and release; the mobile part (8) of the chain tensioner (5) must release without obstacles.

NOTE: If the mobile part doesn't slide freely, it is necessary to replace the chain tensioner (5).

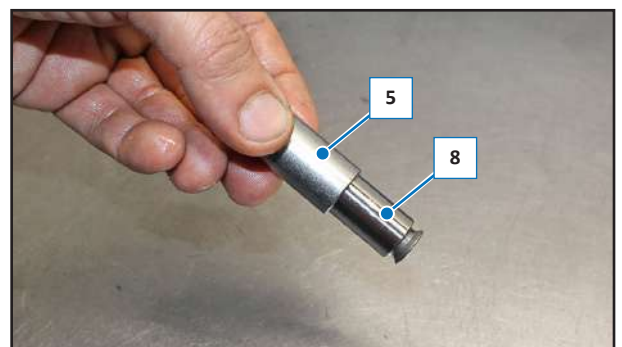

2.3.2 Remounting the chain tensioner

Mount a new OR gasket (6) in the seat of the cylinder; use a screwdriver for positioning.

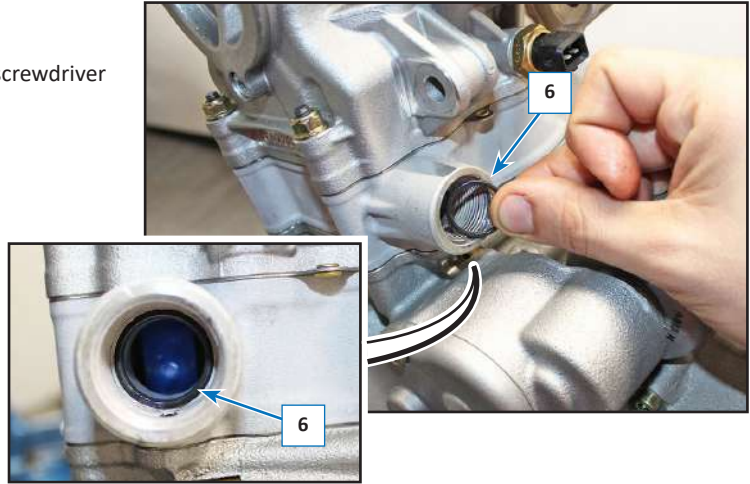

Press the chain tensioner (5) until you hear the last click.

Grease the chain tensioner (5) using grease.

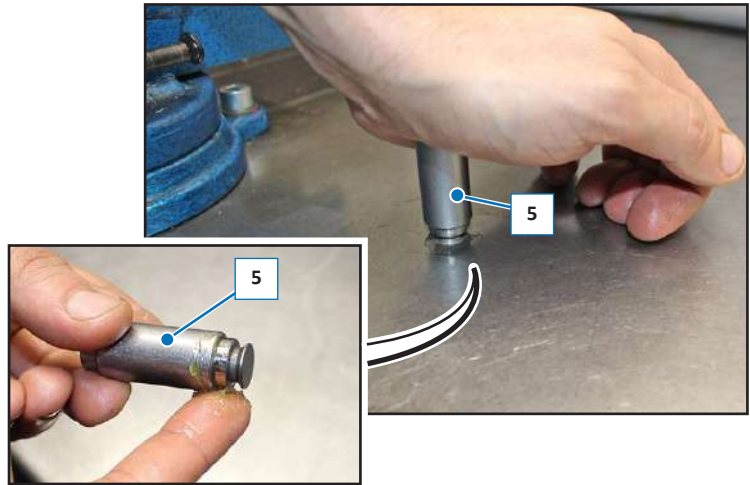

Insert the chain tensioner (5) in the seat of the cylinder.

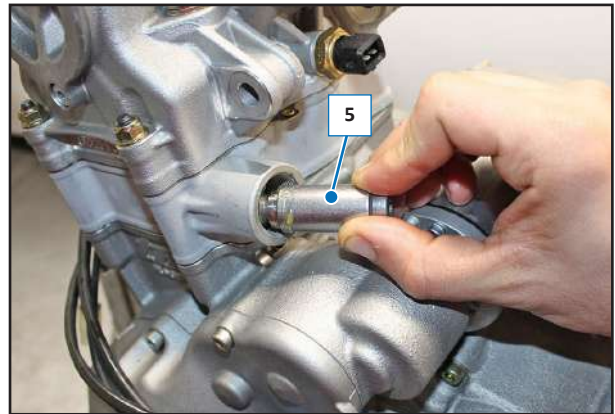

Manually push the chain tensioner (5) so that it inserts correctly on the OR (6) while it enters in its corresponding seat.

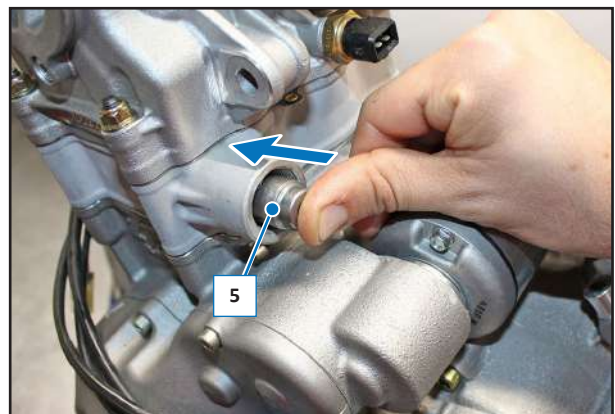

Mount the chain tensioner plug (3), screwing it by hand, making sure you replaced the copper washer (4).

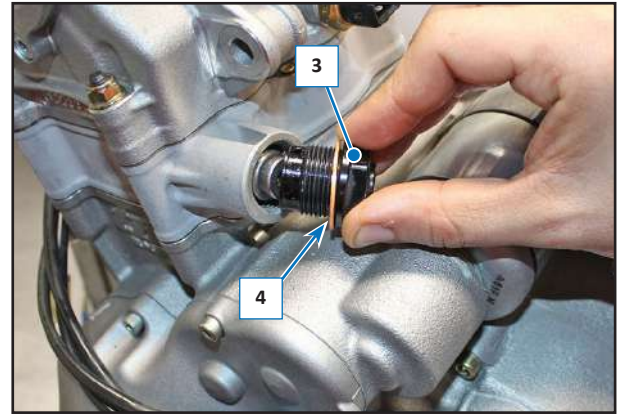

Tighten the plug (3) with a tightening torque of 33 Nm (3,3 kgm, 24,34 ft/lb).

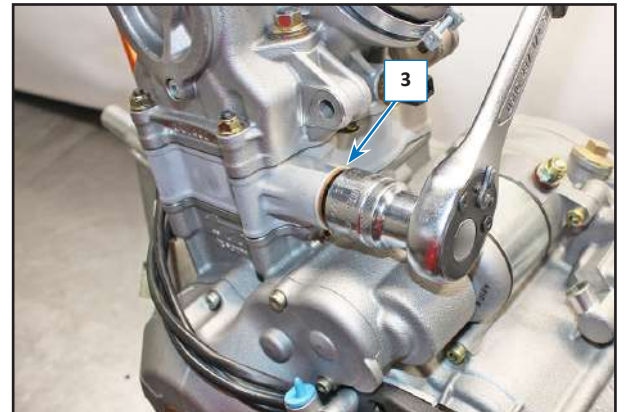

Use a punch (9) to push the chain tensioner so that the mobile part is released while tensioning the chain.

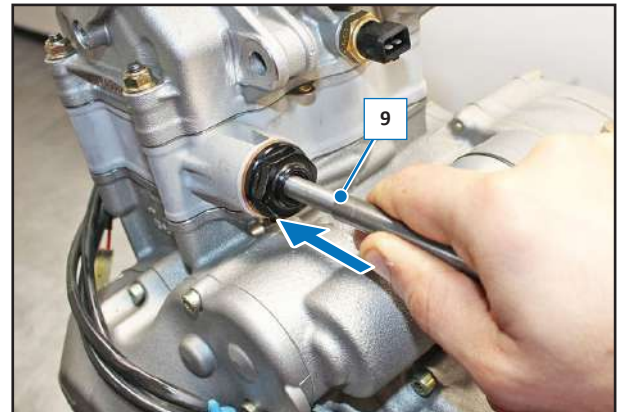

Remount the plug (1) making sure you replaced the OR gasket.

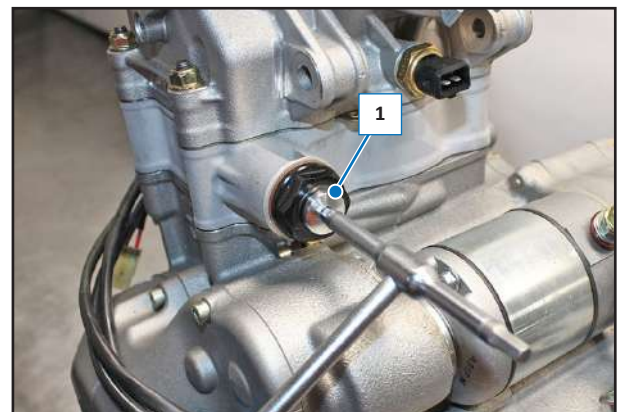

2.4 HEAD

2.4.1 Head removal

Remove the head cover, the camshafts and the chain tensioner as described in the corresponding paragraphs.

Unscrew the three screws (1) of the timing system drive gear cover (2).

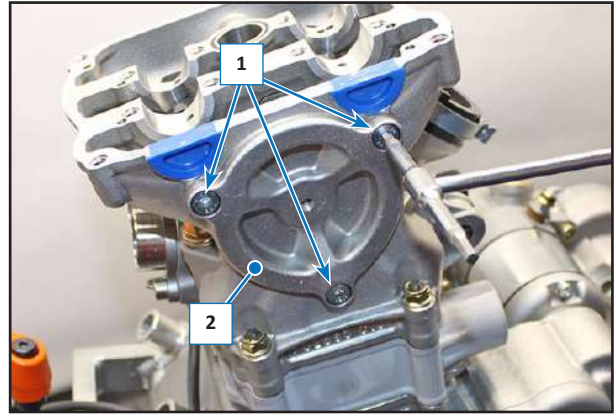

Screw a 6 mm screw (3) on the cover (2).

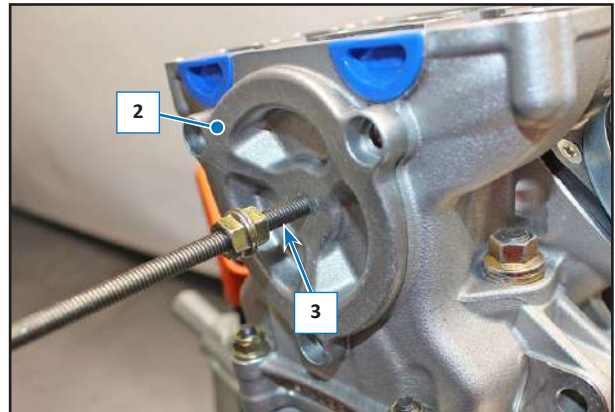

Remove the cover (2) by means of a snug puller (4)

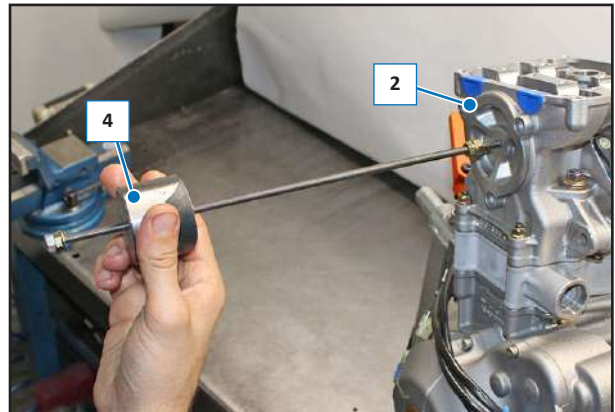

Recover shim (5) by removing the cover (2).

Remove the gasket (6) of the cover (2) and replace it.

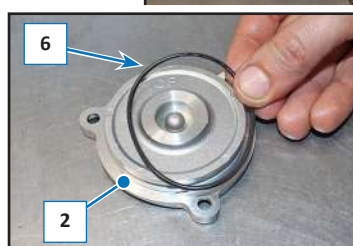
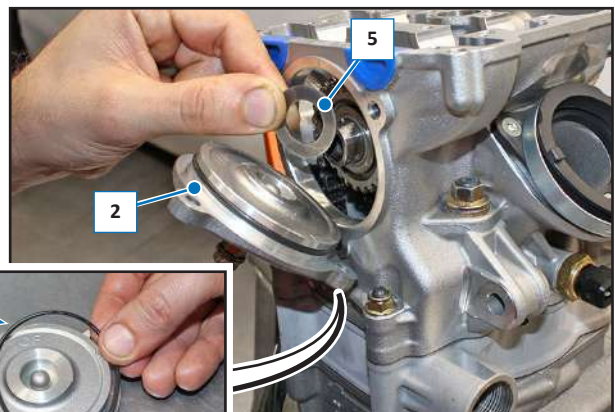

Remove the bushing (8) while keeping the timing system drive gear (7) steady (7).

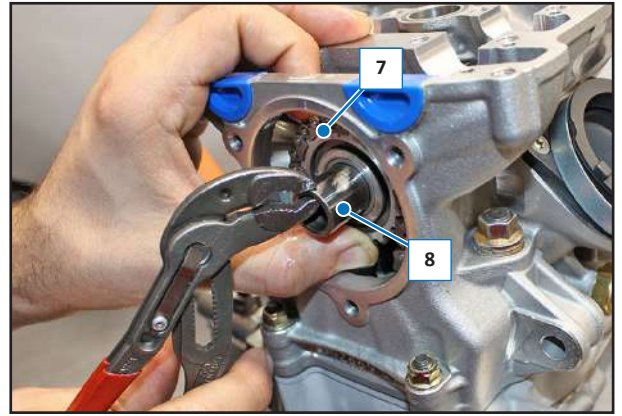

The bushing (8) must come out together with the needle roller bearing (9).

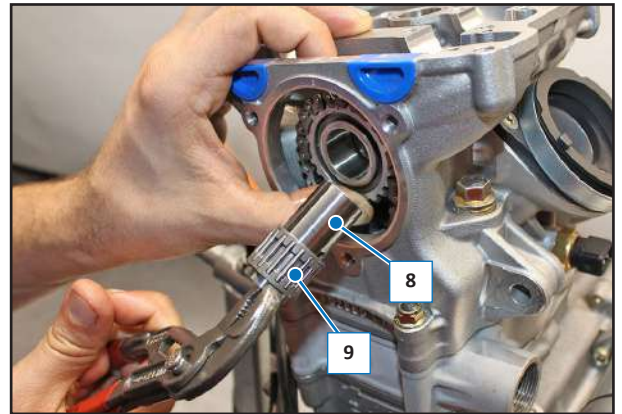

Remove the chain (10) from the drive gear (7).

Recover the rear shim (11).

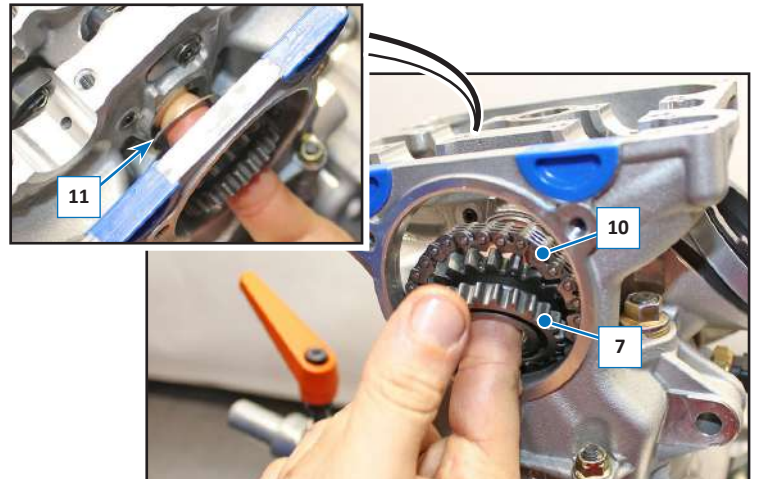

Completely remove the drive gear (7) complete with the shim (11) and let the chain (10) fall inside the carter.

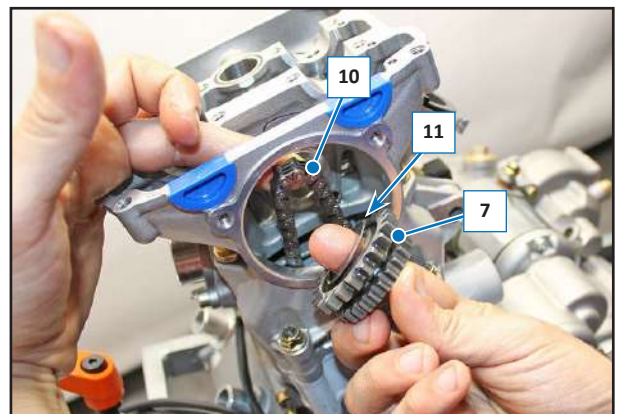

Loosen the two lateral nuts (12) at the left of the head.

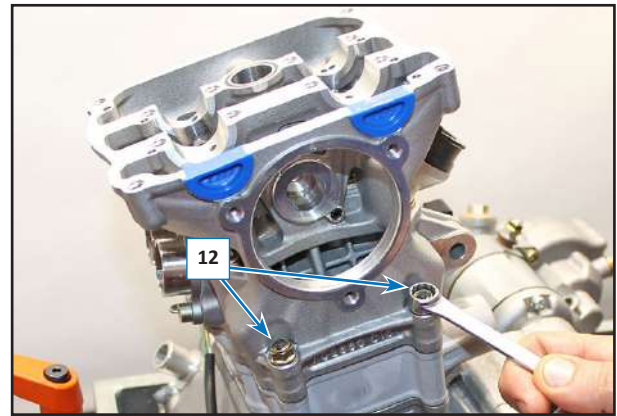

Unscrew the nuts (13) of the head studs (exhaust side) and collect the corresponding washers (14).

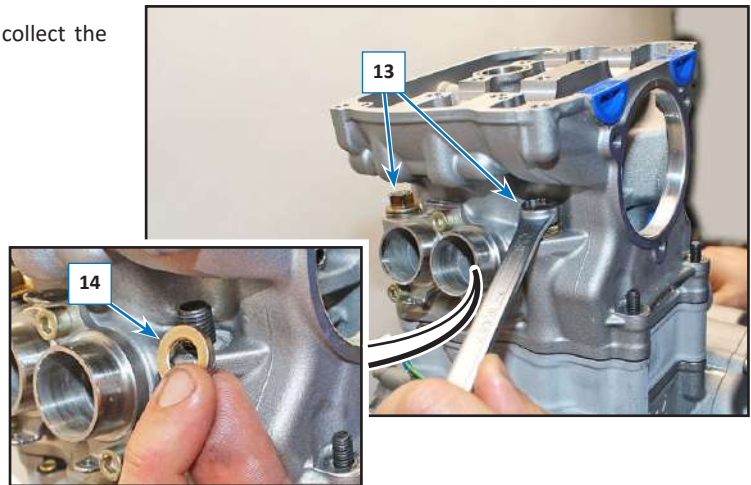

Unscrew the nuts (15) of the head studs (intake side) and collect the corresponding washers (16).

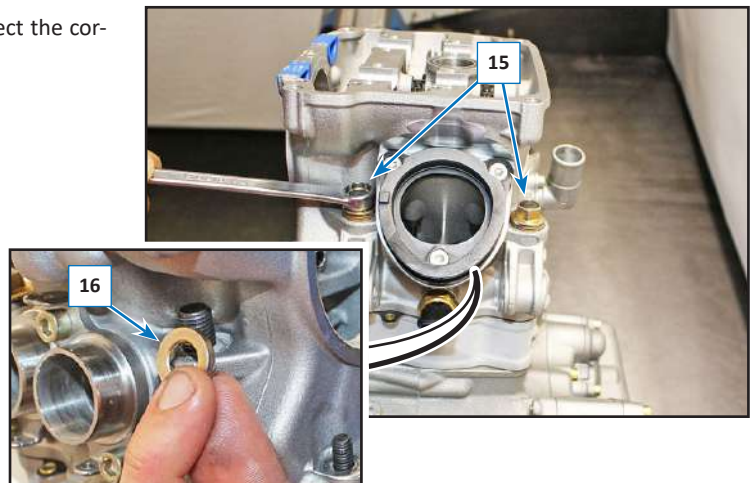

Lift the head (17) and remove it.



Remove the gasket (18).



Collect the centring bushings (19).

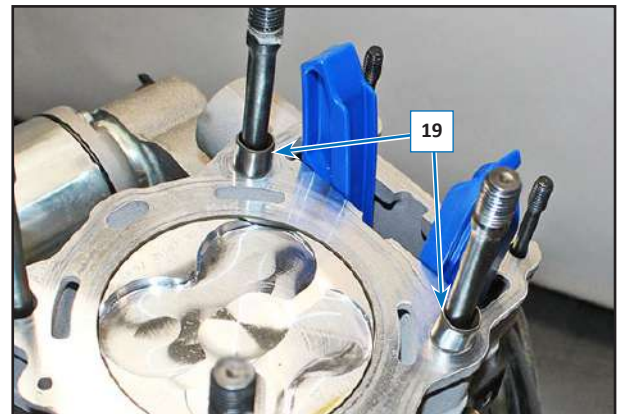

2.4.2 Head dismantling

NOTE: Mark all components in a way to re-mount the exactly in the same place from where they were removed.

Retrieve the pads (1) if they have not been already removed.

Unscrew the screw (2) of the left intake rocker arm pin locking plate (3) and remove both of them.

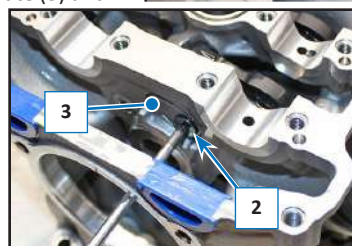
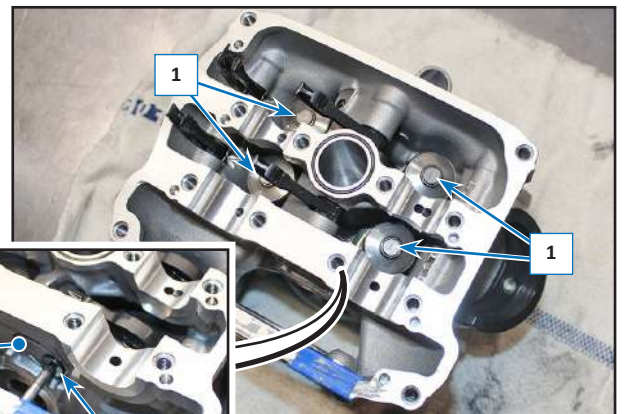

Screw an M5 screw on the pin (4) and remove it together with the rocker arm (5).

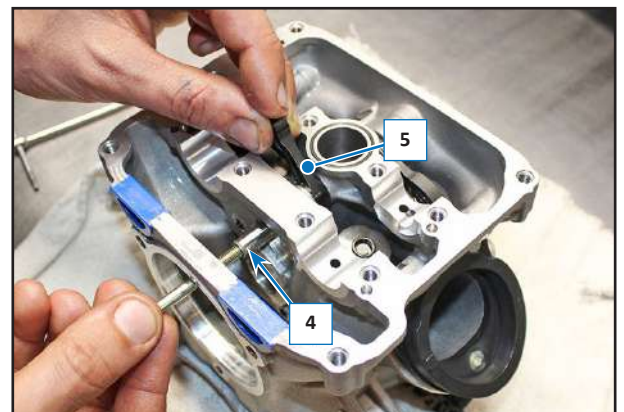

Unscrew the screws (6) of the rocker pins.

Check the status of the OR gasket (7), replace it if worn.

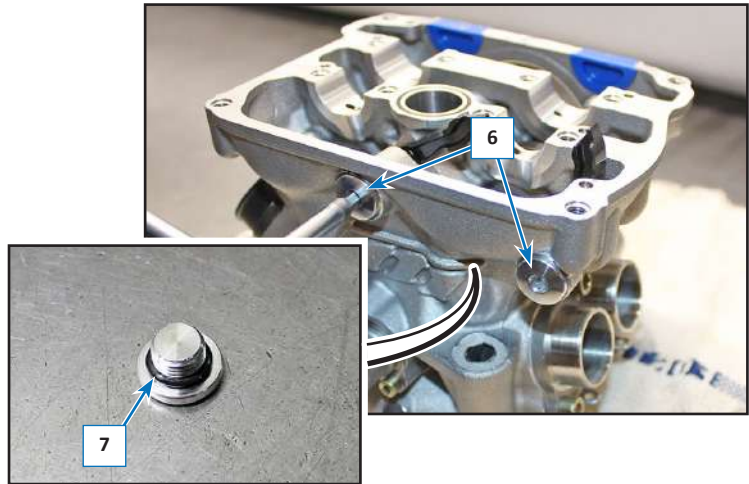

Screw an M5 screw (8), remove the pin (9) and recover the right intake rocker arm (10).

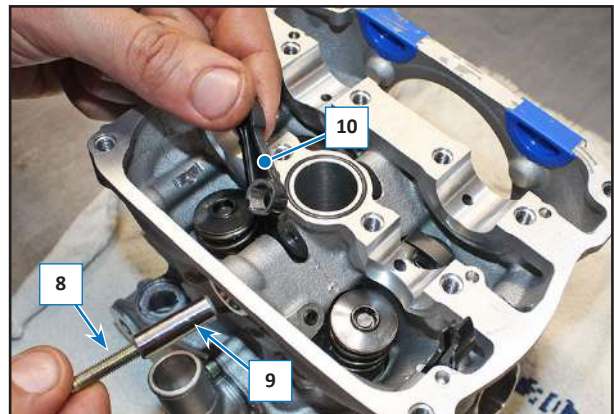

Screw an M5 screw M5 (11) on the pin (12) and remove the rocker arms (13), exhaust side.

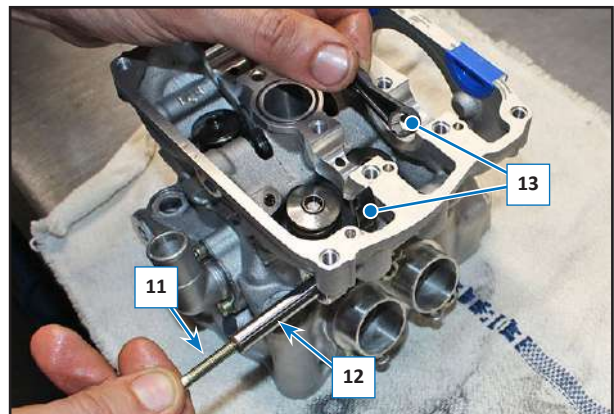

NOTE: The rocker arm (13a) on the right exhaust side is different from the other rocker arms.

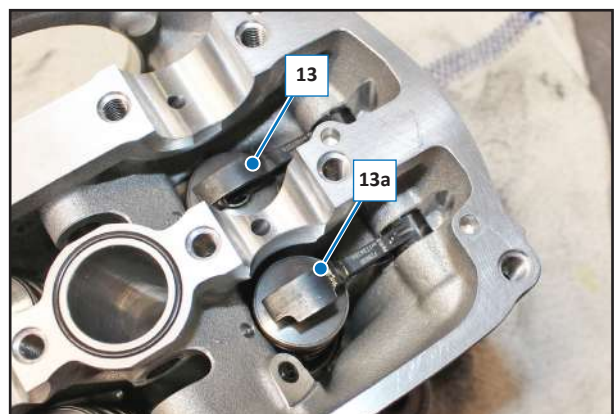

Using the relevant tool, compress the valves.

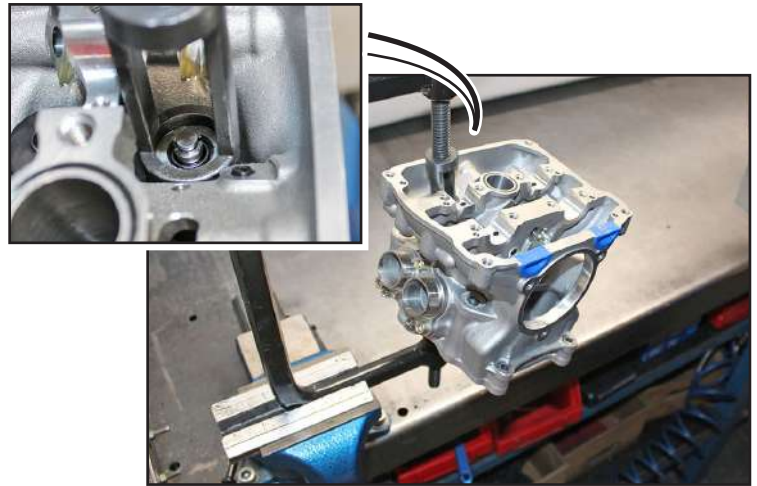

Use a magnet to remove the two half cones (14).

NOTE: Pay attention not to damage the support surfaces of the gaskets or of the combustion chamber. Make sure that the separator tool is upright, otherwise the valve stem may bend.

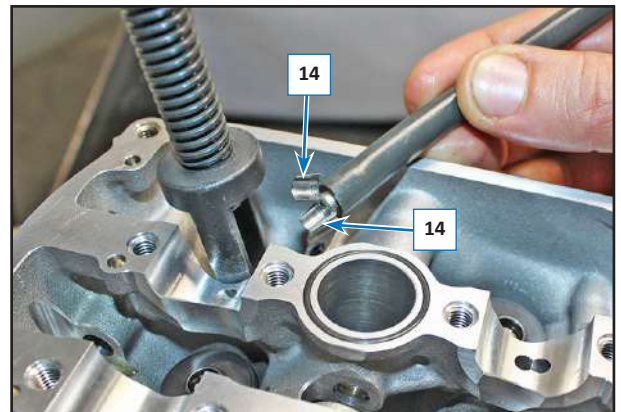

Remove the tool and remove the double spring (15) and the relative valve (16).

NOTE: Before sliding the valve out, check that there are no burrs on the stem, so that the valve-guide and relative oil seal are not ruined. If this is not the case, sand lightly to remove the burrs.

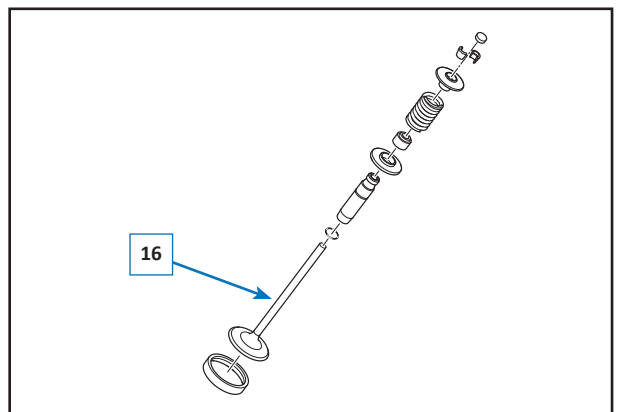
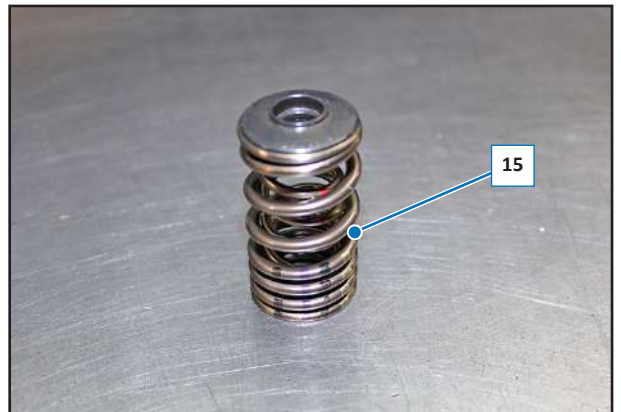

If ruined, remove the oil seal (17), the valve-guide (18), the relative OR gasket (19) and the valve seat (20).

NOTE: The valve seats and the valves are different regarding intake and exhaust.
Do not invert. Mark them before disassembling them in order to re-mount them correctly.

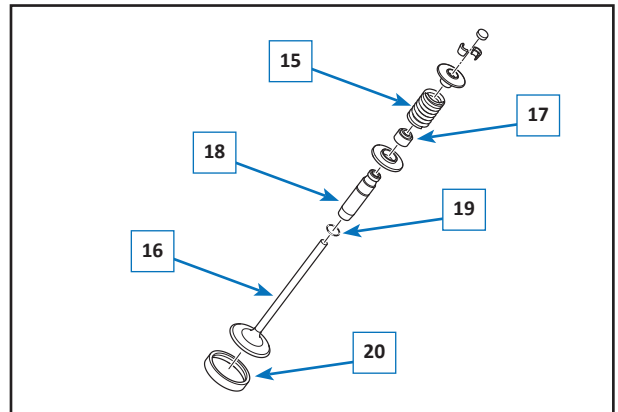
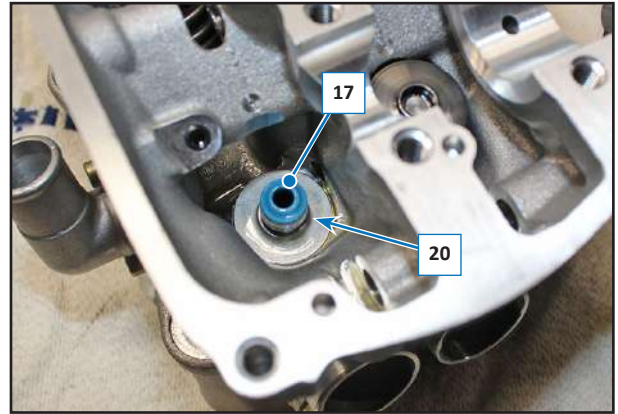

2.4.3 Head re-assembly

If disassembled, re-mount the valve seat (20), the valve-guide (18) and the OR gasket (19) and the oil seal (17). Lubricate the components with engine oil.

Use engine oil to lubricate the valve stem (16) and insert it into the valve-guide, paying attention not to pinch the oil seal (17).

Mount the double spring (15) with relative plates (21) and (22).

NOTE: Pay attention on re-mounting since the upper and lower plates are not the same.

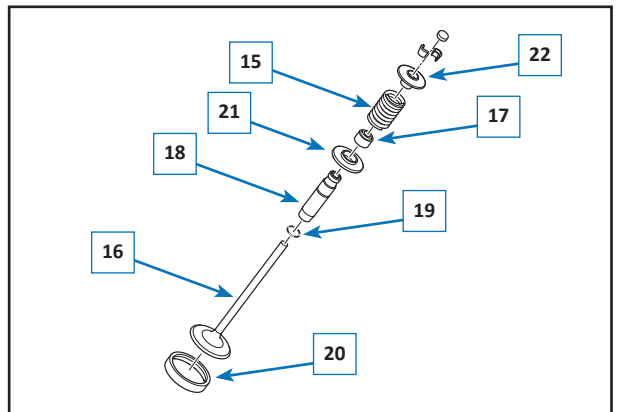

Using the relevant tool, compress the double spring (15) and insert the two half cones (14) onto the valve stem; release the double spring and remove the tool. Check that the half cones (14) are positioned correctly on the stem using a rubber hammer to tap the upper valve stem to position it correctly.

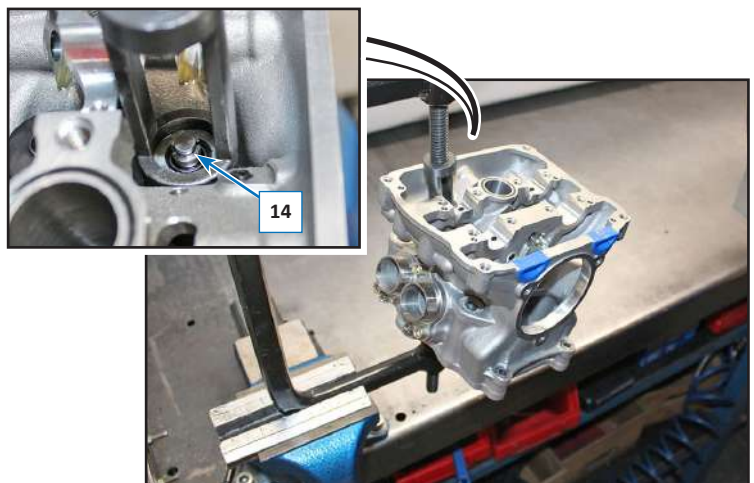

Lubricate the pin (12) of the exhaust side rocker arms (13) with engine oil, remount them in the same exact position and unscrew the M5 screw (11).

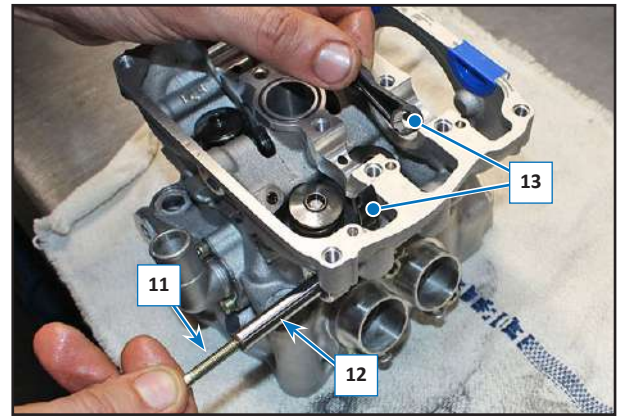

Lubricate the pin (9) of the right intake rocker arm (10) with engine oil and remount it in the same exact position and unscrew the screw (8).

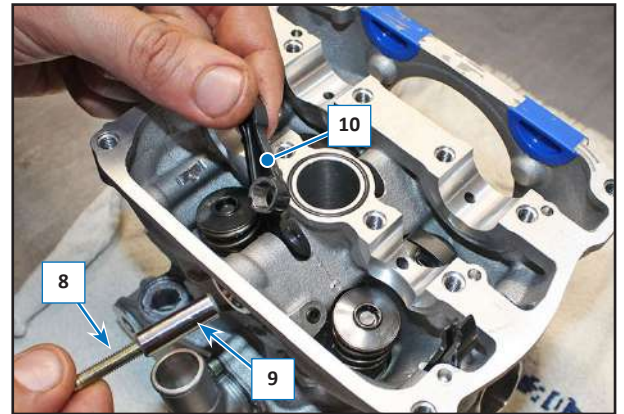

Lubricate the pin (4) of the left intake rocker arm (5) with engine oil and remount it in the same exact position and unscrew the M5 screw.

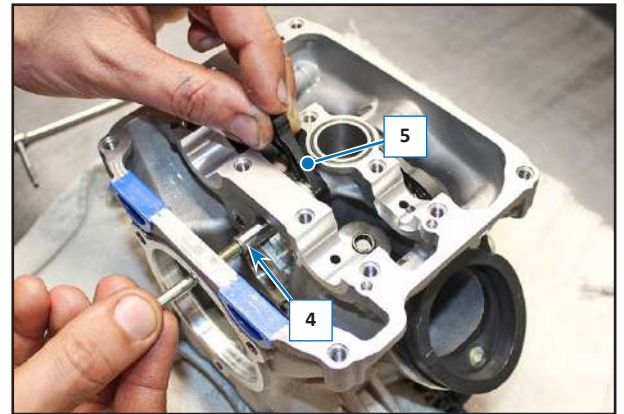

Screw the screw (2) with the plate (3) applying loctite 243 on the thread.

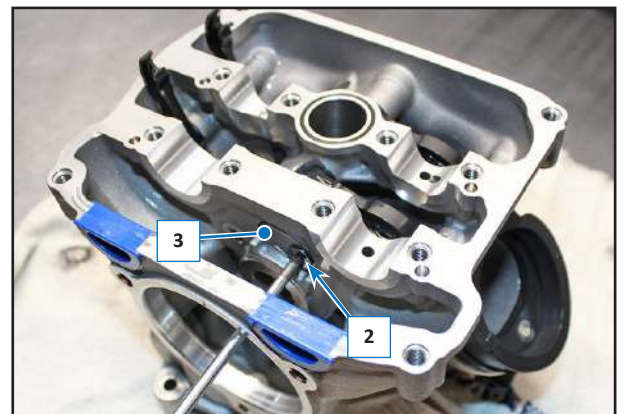

Screw the screws (6) checking that the OR gasket (7) has been replaced.

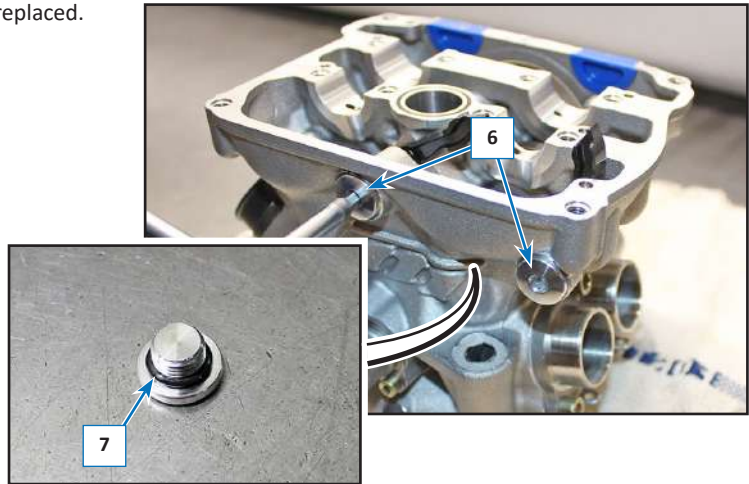

Remount the pads (1) in the same position from which they have been removed.

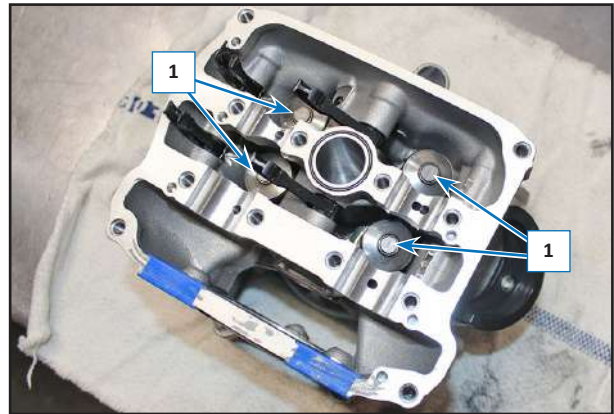

2.4.4 Head re-mounting

Position the centring bushings (1) on the stud bolts (2).

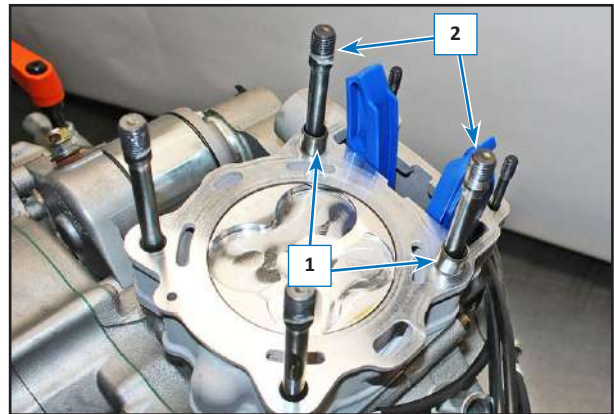

Replace the gasket (3) at every disassembly, and then mount it on the cylinder.

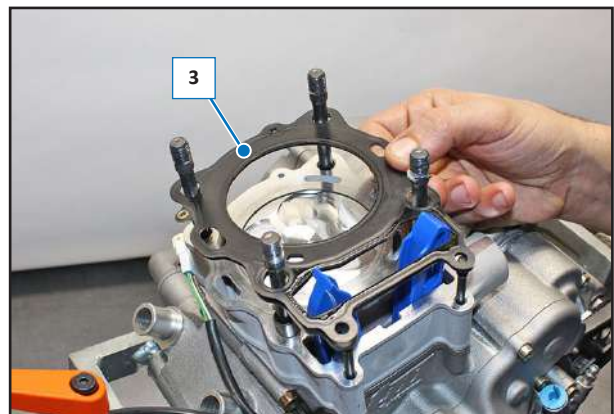

Insert the head (4) on the studs.



Screw the nuts (5) of the stud bolts, making sure the washer (6) has been positioned below.

Cross-screw them following these 3 steps:

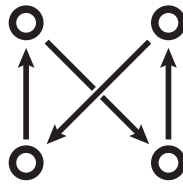

Step one: tighten them with a torque of 20 Nm (2,0 kgm, 14,75 ft/lb).

Step two: tighten with a torque of 32 Nm (3,2 kgm, 23,60 ft/lb).

Step three: tighten with a torque of 48 Nm (4,8 kgm, 35,40 ft/lb).

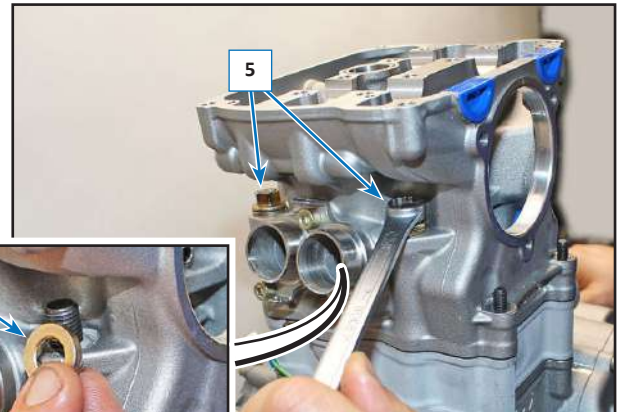

NOTE: It is recommended to replace the self-locking nuts (5) to guarantee the head is perfectly sealed.

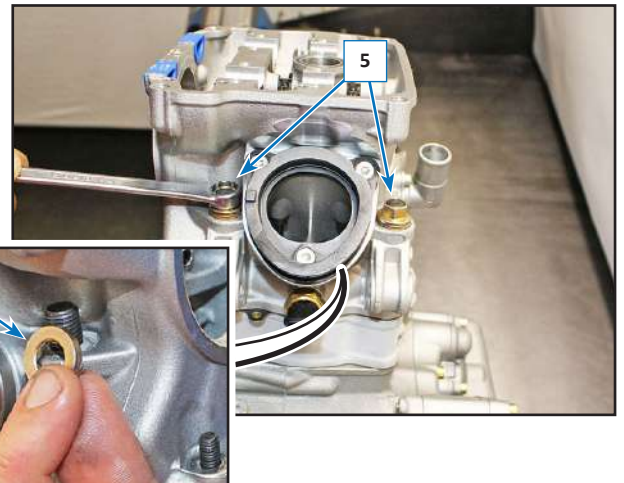

Apply graphite grease on the threads and screw the two nuts (7) by hand, then tighten them with a tightening torque of 12 Nm (1,2 kgm, 8,85 ft/lb)

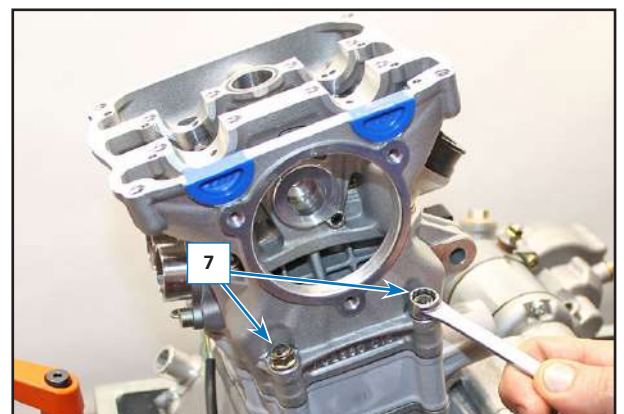

Recover the chain (8) from the inside of the carter by means of a hook or of a magnet. Insert, inside the head, the timing system drive gear (9) together with the corresponding internal shim (10).

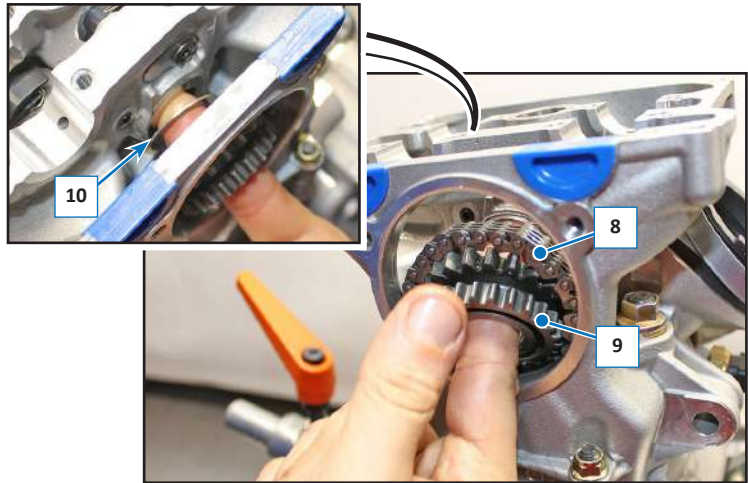

Correctly place the timing chain (8) on the drive gear (9).

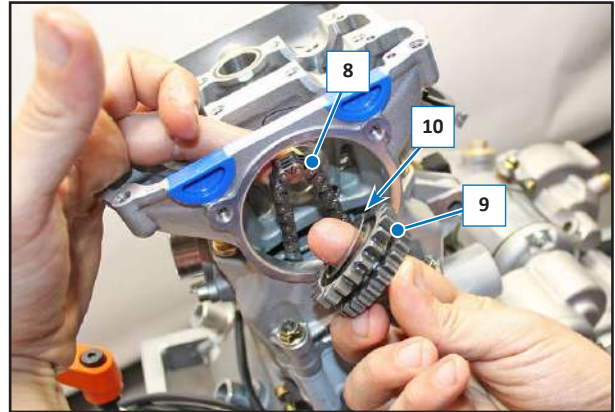

Keep the drive gear (9) in position, lubricate the pin (12) and the bearing (11) with engine oil and mount the drive in its corresponding seat of the head, locking it (9) in position.

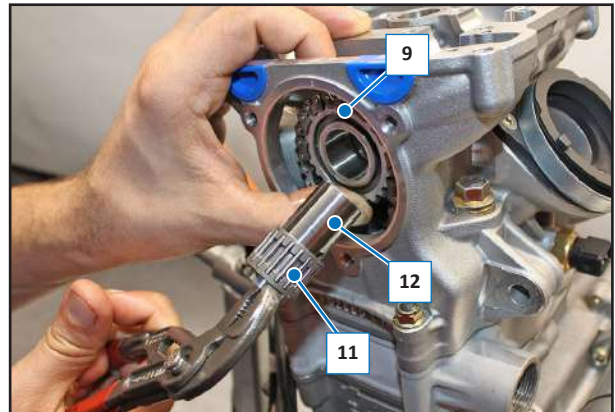

Mount the shim (15) and the cover (13) taking care to replace the gasket (14) and positioning the cover (13) with the writing "TOP" on the top part of the head.

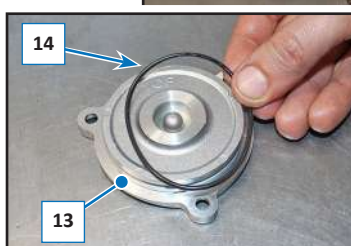
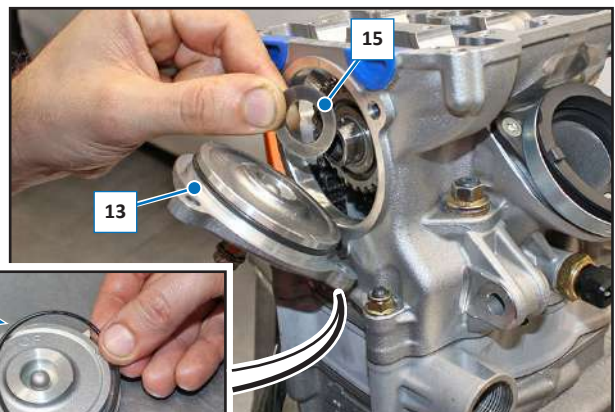

Screw the screws (16) with a tightening torque of 1 Nm (0,1 kgm, 0,74 ft/lb).

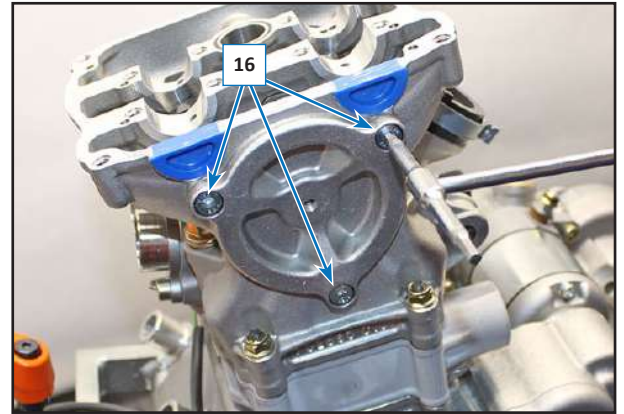

2.5 CYLINDER AND PISTON

2.5.1 Cylinder and piston removal

Remove the head as described in the relative section.

Remove the cylinder (1) by sliding it from the stud bolts.



Remove the lock ring (2) of the piston (3)

Extract the pin (4) and remove the piston (3).

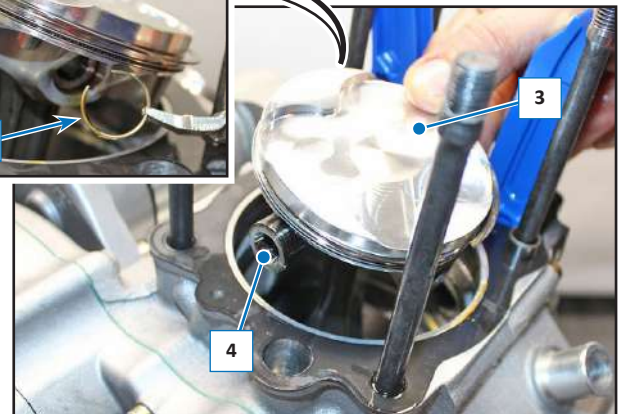
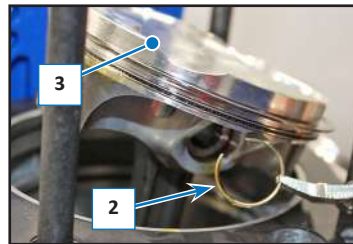

Remove the gasket (5).

Remove the two OR gaskets (6) and remount two new gaskets.

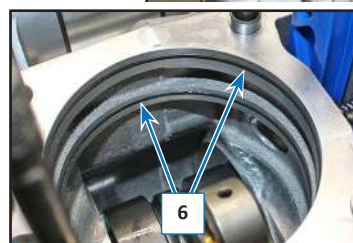
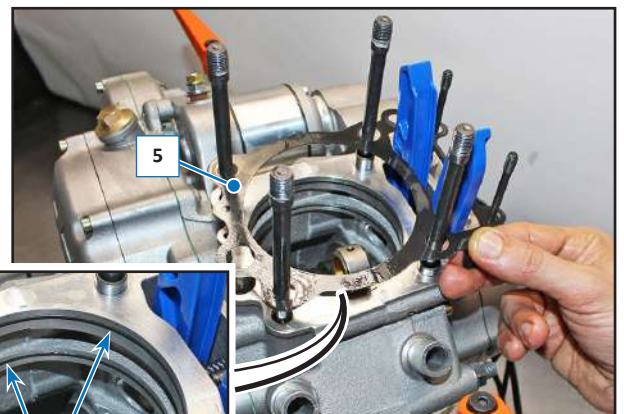

2.5.2 Strap and oil scraper replacement and mounting

Clean the housing (1) of the straps on the piston from any carbon deposits.

NOTE: Apply engine oil on the straps before mounting them on the piston.
 Be careful not to scratch the piston when re-mounting.
 Do not widen the straps excessively during mounting, so that they are not damaged.

First, install the oil scraper (2), inserting the spacer (3) and the two rings (4) and (5) in a way that they go fully home onto the edge of the spacer. Install the upper strap (6), positioning the face engraved with "N" on the upper part. Check that the strap and the oil scraper rotate freely around the piston and are not obstructed. Position the open part of the strap (6), of the spacer (3) and of the rings (4) and (5) as indicated in the figure, before re-mounting the piston in the cylinder.

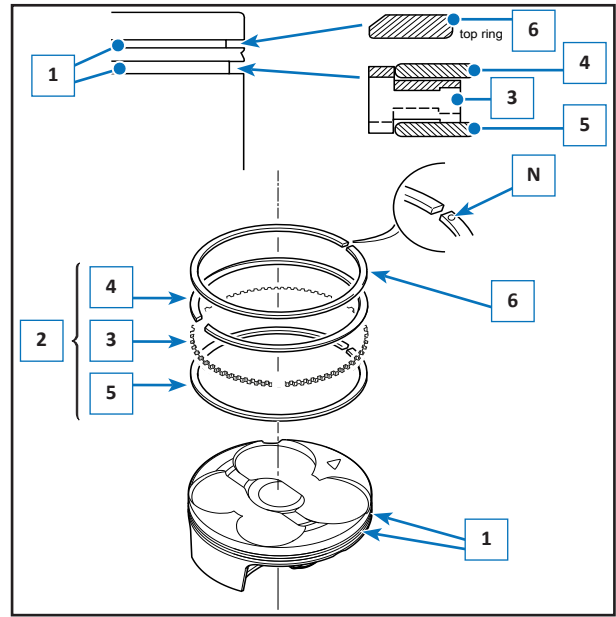

2.5.3 Cylinder and piston coupling

If the piston must be replaced, for correct coupling, it is necessary to take the crosswise measurement of the internal diameter of the cylinder at a distance from the upper part of 30 mm and 60 mm. Use a relevant micrometer for internal diameters to take the measurement. Cylinder piston coupling play is 0.05 mm +/- 0.005 mm.

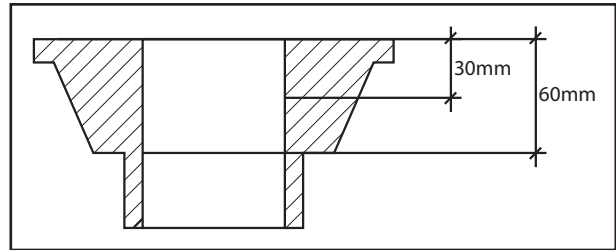

2.5.4 Cylinder and piston re-mounting

Oil the barrel of the cylinder with engine oil.

Mount the piston (1) on the cylinder (2) on a work bench.

NOTE: Remount the piston (1) on the cylinder (2), making sure the arrow (3) is pointed towards the exhaust.

Check that the strap and the oil scraper are positioned as indicated in paragraph "Strap and oil scraper replacement and mounting".

Mount the piston pin (4)

Mount the two centring bushings (5) and raise the connecting rod head (6).

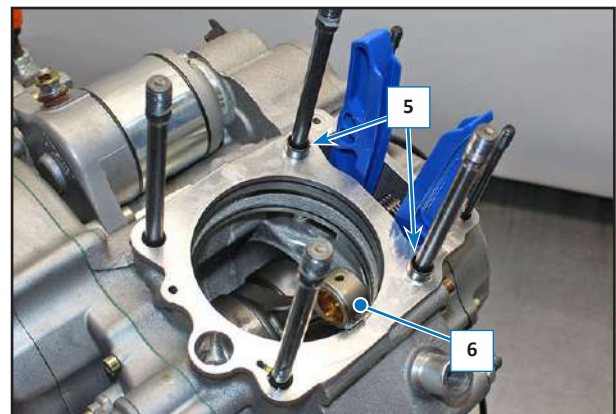
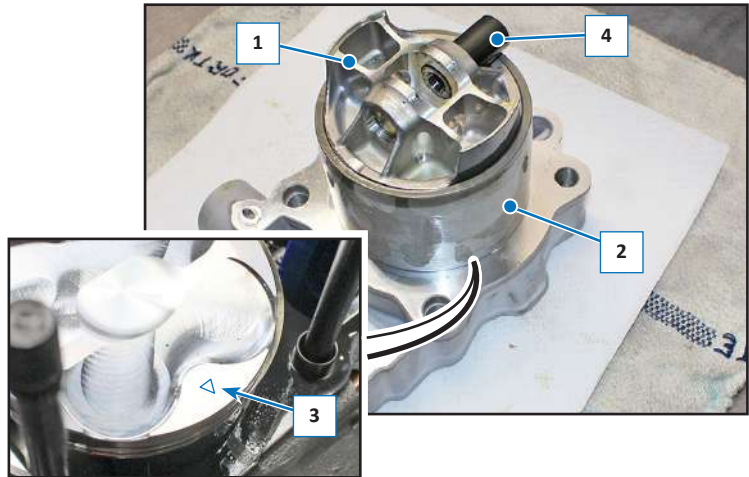

Insert a new gasket (7).

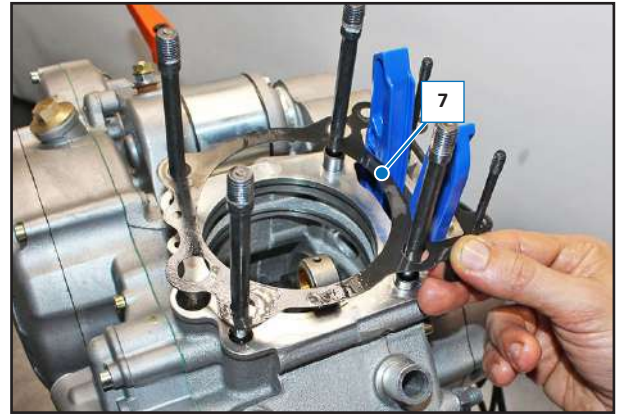

Mount the cylinder (2) when the piston is mounted on the stud bolts and manually insert the piston pin (4) on the connecting rod head (6) with the aid of an aluminium punch (8).

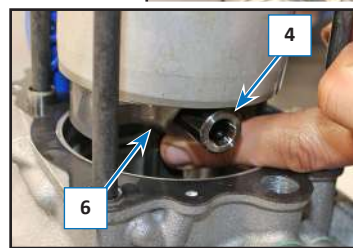
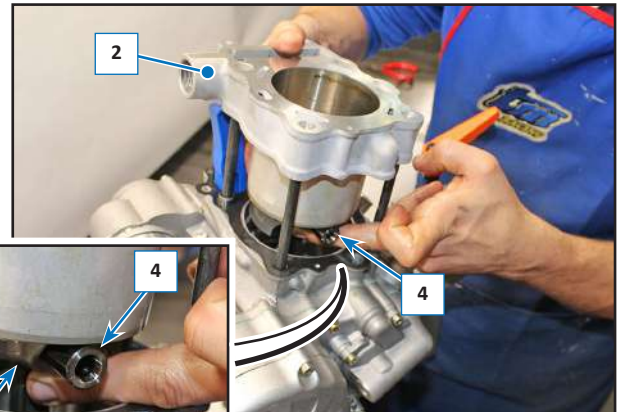

Mount the retaining ring (9).

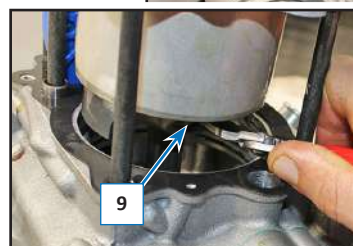

Completely insert the cylinder (2) in the stud bolts (10) by inserting the two sliders.

NOTE: If the cylinder or the piston have been replaced, it is necessary to check compression by operating as described in paragraph "Compression check".

Re-mount the head as described in the relative section.

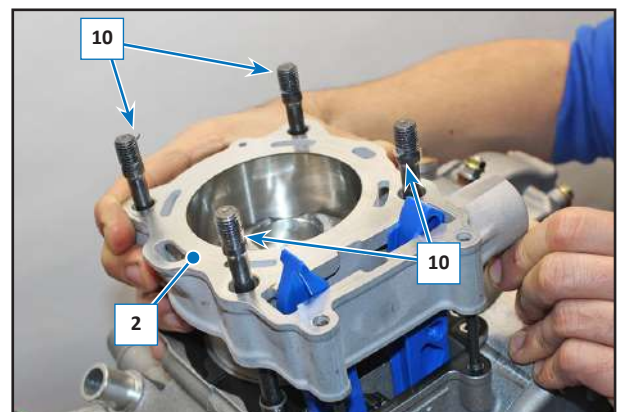

2.5.5 Compression check

With replacement of the cylinder or piston, it is necessary to check that the distance between the piston crown and the upper surface of the cylinder is in within correct tolerance.

After having mounted the cylinder, insert the relevant spacers (1) and tighten the nuts (2) with a torque of 25 Nm 2.5 kgm, 18.43 ft/lb .

Position the piston at the top dead centre.

Position the tool (3) with relative micrometer on the upper surface of the cylinder and zero.

Move the pushrod (4) of the micrometer on the top flat part of the piston, first on intake side, then exhaust side, and detect the dimension.

Correct compression:

0.55 ± 0.05 mm

If the measurement does not lie within the tolerance established, the metal gasket (7) of the spacer must be purchased as a spare part, suitable to return within tolerance.

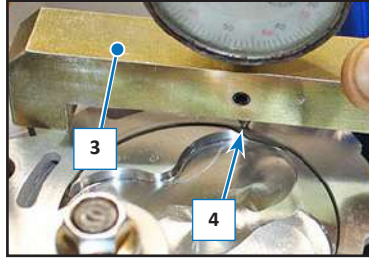
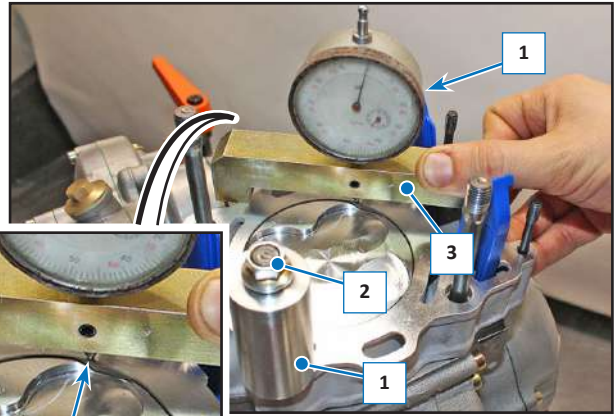

2.6 TEMPERATURE SENSOR REPLACEMENT

Unscrew the sensor (1) and replace it by tightening a new sensor with torque of 30 Nm, 3.0 kgm, 22.12 ft/lb plus three bond 1215 sealant paste.

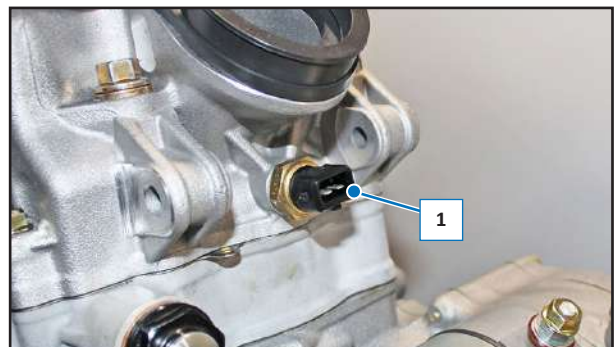

2.7 INTAKE MANIFOLD REPLACEMENT

To remove the intake manifold (1), unscrew the three screws (2).

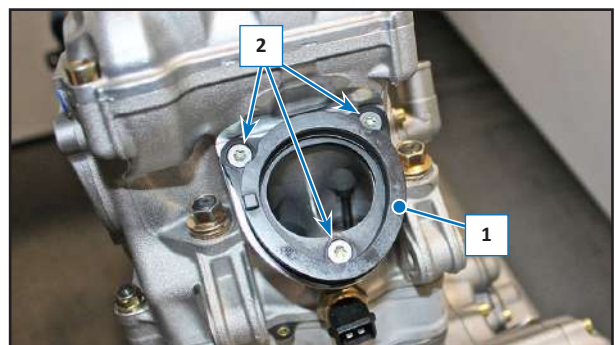

2.8 HEAD EXHAUST MANIFOLD REPLACEMENT

To remove the exhaust manifold (1), unscrew the three screws (2); at the moment of remounting, use Three bond 1215 paste and screw the screws (2) with a tightening torque of 1,5 Nm (0,15 kgm, 1,11 ft/lb).

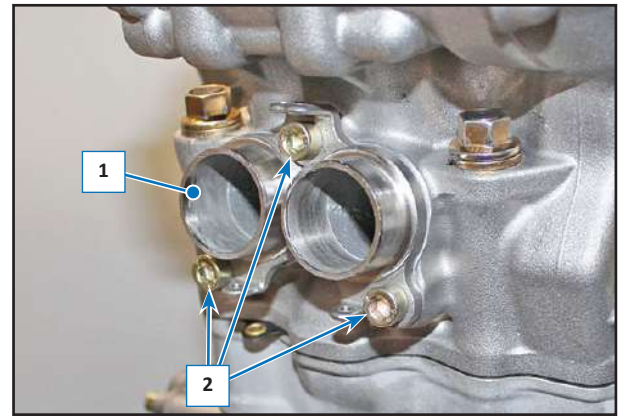

2.9 HEAD COOLING CONNECTION REMOVAL

Unscrew the screws (1) and remove the forks (2).

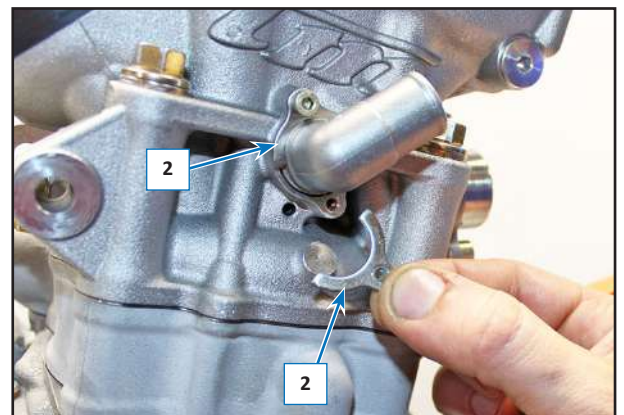
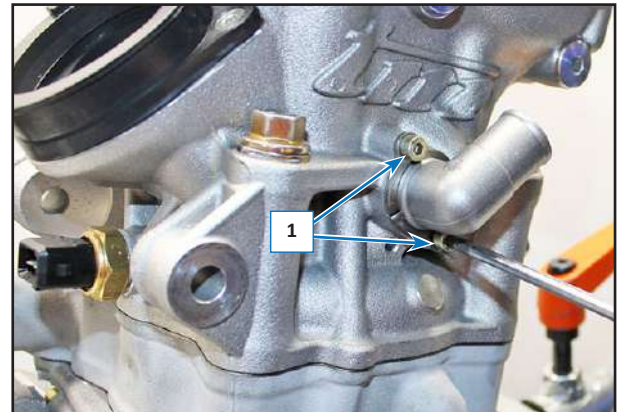

Remove the connection (3) and check the OR gasket (4), replace it if worn.

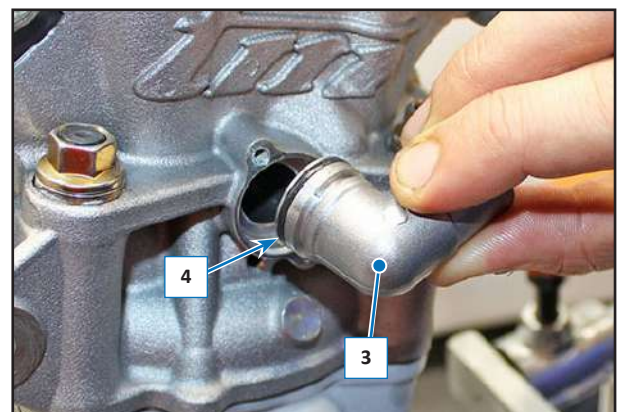

2.10 CLUTCH

2.10.1 Clutch actuator removal with relative command rod

Unscrew the screws (1) and remove the actuator (2) and the pinion protection (3).

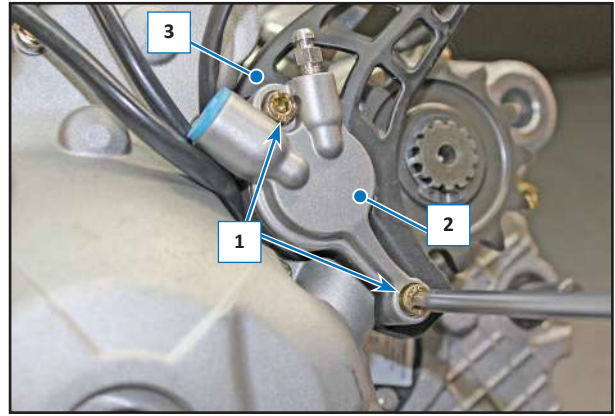

Unscrew the screw (4) and remove the bracket (5).

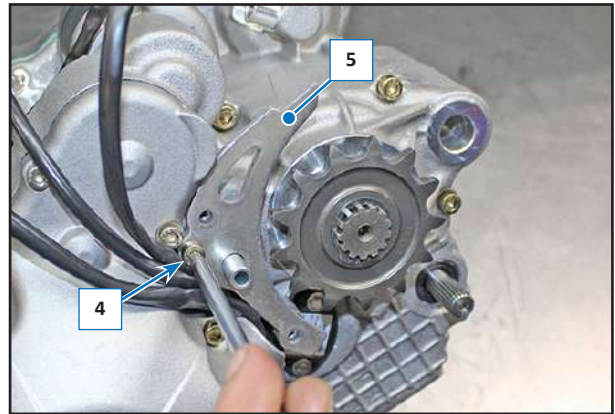

Slide the mushroom (6) out.

NOTE: On re-mounting, check the status of the gasket (7), replace it if ruined.

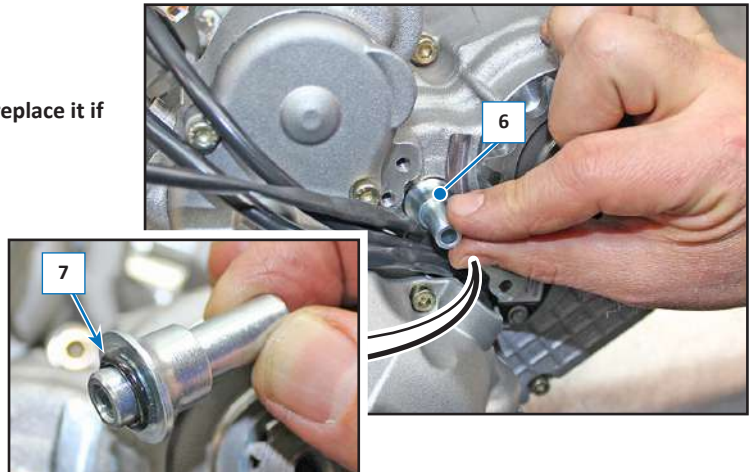

Slide the clutch rod (8) out.

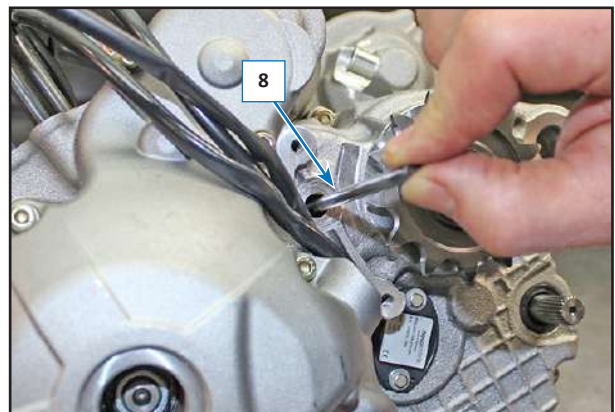

2.10.2 Actuator dismantling

Separate the two parts of the actuator and remove the piston (9).

Check the conditions of the seal (10) and the OR gasket (11); replace them if ruined.

Check the status of the OR gaskets (12), and replace if ruined.

NOTE: On re-mounting, lubricate the gaskets and seal with clutch oil.

Re-mount everything, proceeding in the opposite order to disassembly.

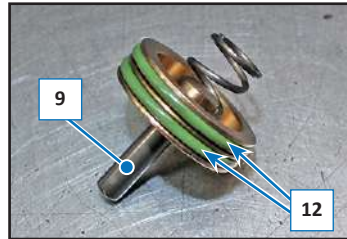
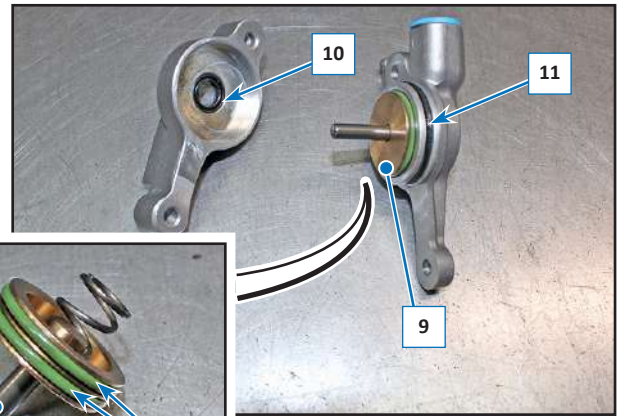

Tighten the screws (1) with a torque of 8 Nm 0.8 kgm/ 5.9 ft/lb.

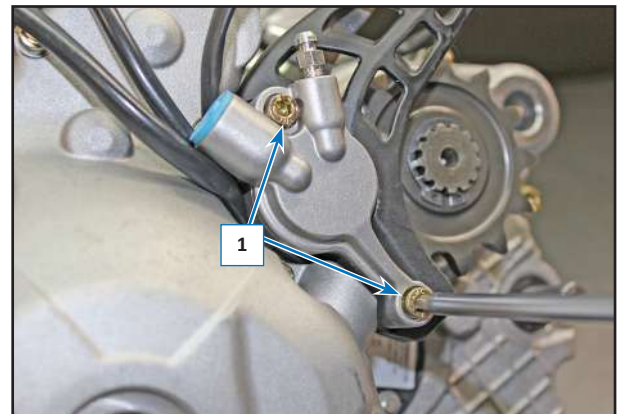

2.11 GEAR SENSOR

Remove the clutch actuator as described in the relative paragraph.

Unscrew the two screws (1).

Use a screwdriver to lever and remove the gear sensor (2).

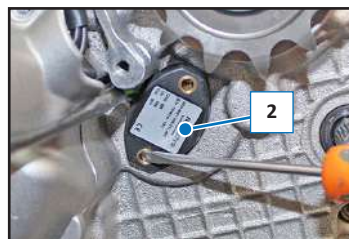
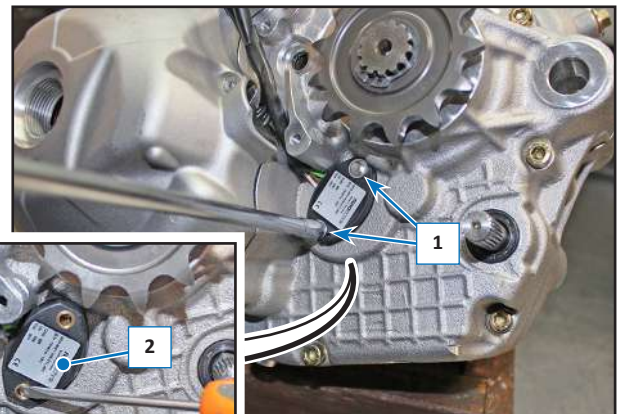

NOTE: Re-mount everything in reverse order to disassembly, paying attention to position the cabling (3) of the sensor in the hollow (4).

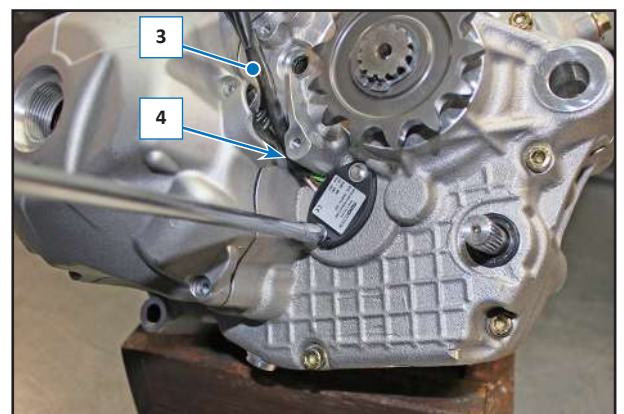

2.12 FLYWHEEL REMOVAL

2.12.1 Flywheel cover

Unscrew the M5-L20 screws (1) and M5-L25 screws (2).

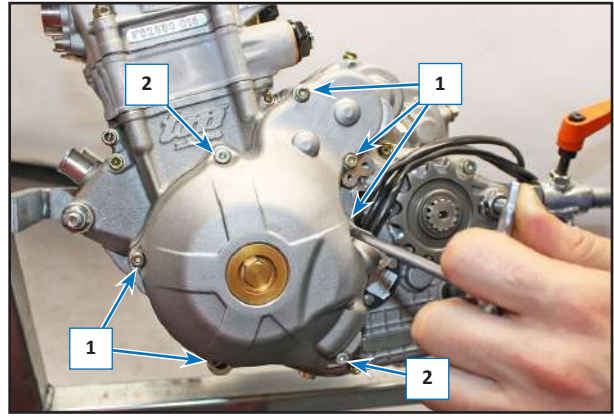

Remove the flywheel cover (3).

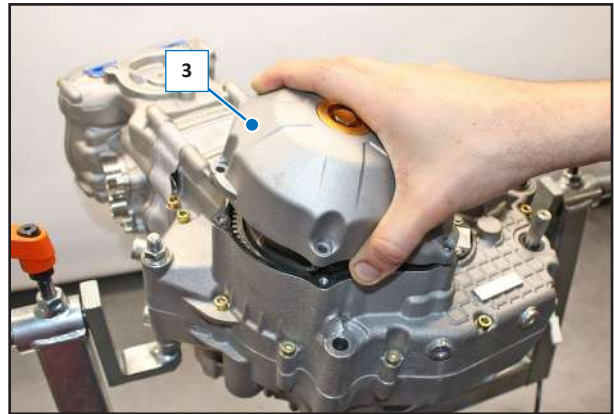

Remove the gasket (4).

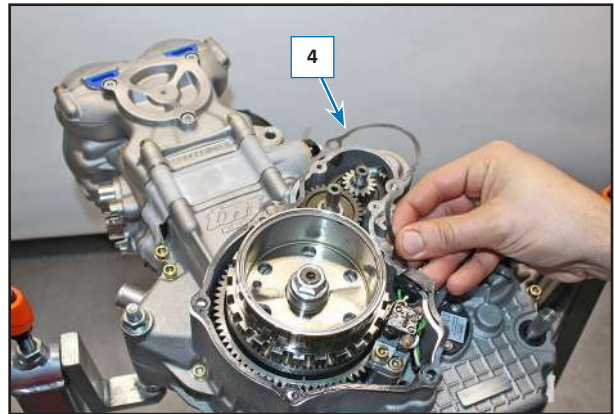

Retrieve the two centring bushes (5).

NOTE: On re-mounting, check that the two centring bushes (5) are positioned correctly and that the gasket (4) is not ruined, otherwise replace.
Tighten the screws (1) and (2) with a torque of 8 Nm (0.8 kgm/ 5.9 ft/lb).

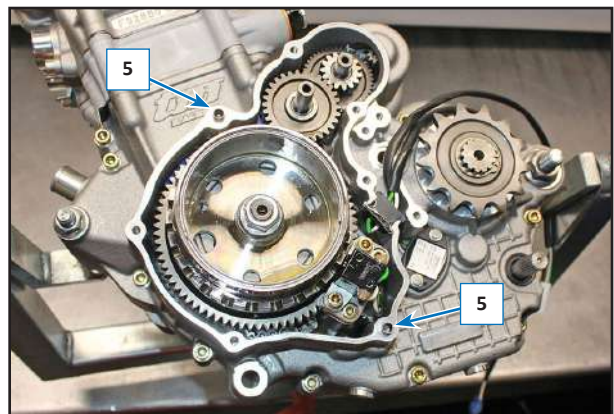

2.12.2 Stator

Disassembly

Remove the flywheel cover as described in the relative section.

Unscrew the screws (1) that secure the stator (2).
 Unscrew the screws (3) and remove the stop plate (4).
 Remove the stator (2) with the relative cabling.

Mounting

Re-mount the stator (2), tightening the screws (1) to a torque value of 5 Nm (0.5 Kgm - 3.68 ft/lb + Loxeal 82-33).

Make sure the rubber cap (5) is fitted correctly on the cover and then tighten the two screws (3) of the stop plate (4) with a torque of 4 Nm (0.4 kgm, 2.95 ft/lb).

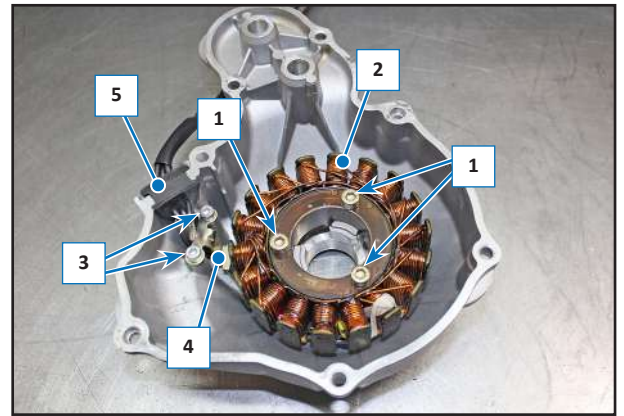

2.12.3 Pick-up

Unscrew the two screws (1) and remove the pick-up (2).

On re-mounting, check that the bushes (3) and the washers (4) are positioned correctly.

Tighten the two screws (1) with a torque of 8 Nm (0.8 kgm, 5.9 ft/lb) positioning the pick-up (2) on the threaded holes (5) nearest to the rotor.

Make sure the rubber cap (6) is fitted correctly on the guard.

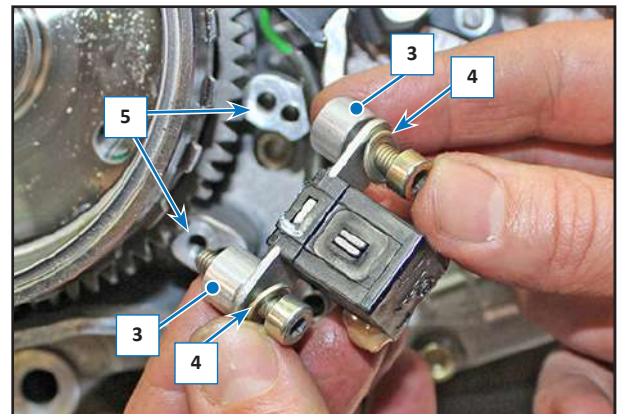
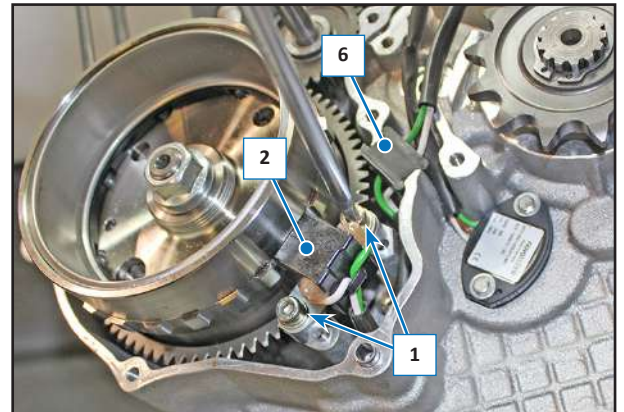

NOTE: On re-mounting, check the distance between the pick-up (2) the reference notch (7) of the flywheel is between 0.7-1.0 mm.

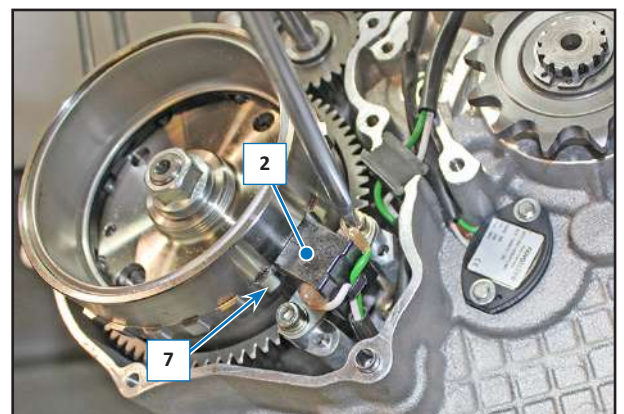

2.12.4 Rotor
Disassembly

Block rotor rotation (1) and use an impact gun to loosen the nut (2) with relative curve washer.

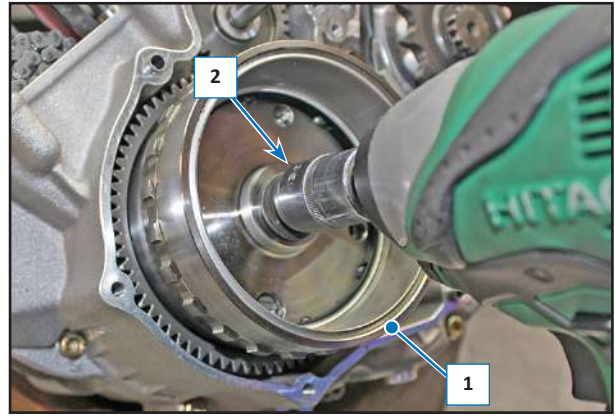

Screw the extractor (3) onto the thread of the rotor (1) and tighten the screw (4) to detach the rotor (1) from the crankshaft.

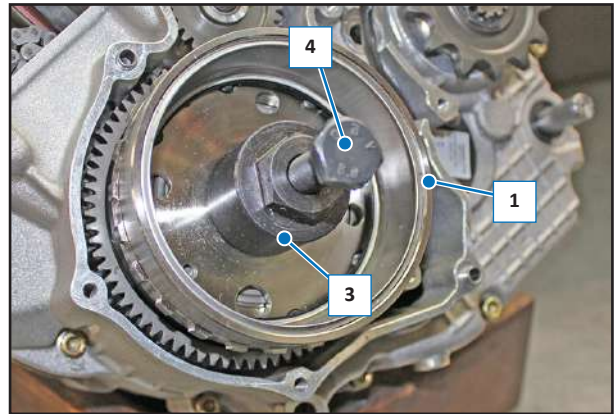

Remove the complete rotor (1).



Retrieve the key (5).

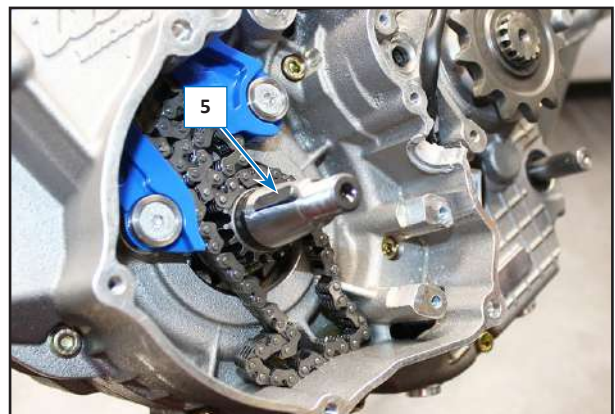

Remove the distribution chain (6).

NOTE: Check that the distribution chain (6) and the relative gear (7) on the crankshaft are not worn, otherwise replace (refer to the relative paragraph for replacement of the crankshaft).

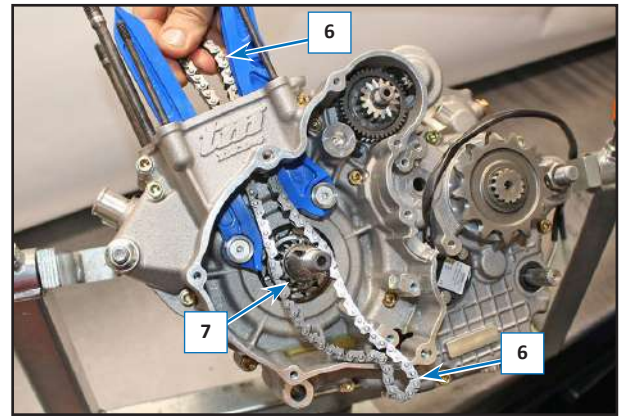

Unscrew the screws (8) and remove the sliders (9), recover the spacers (10).

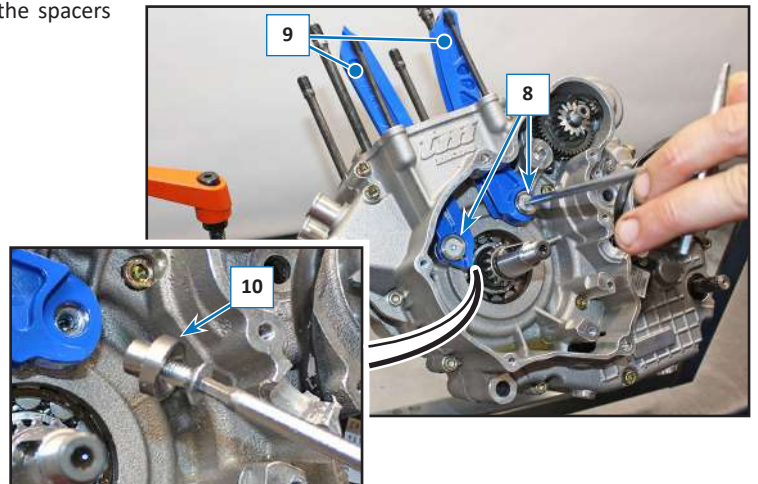

Re-mounting

Re-mount everything, proceeding in the opposite order to disassembly, making sure to: Remount the sliders (9) together with their corresponding spacers (10) by screwing the screws (8) with a tightening torque of 10 Nm, (0,1 kgm, 0,72 ft/lb) + Loxeal 82-33 .

Position the distribution chain (6) correctly.

Make sure the key (5) is properly positioned in its housing.

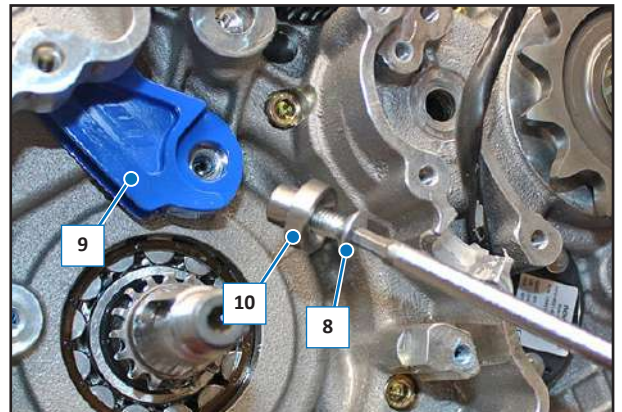

Re-mount the fly wheel (1).

Tighten the nut (2) with relative curve washer with a torque of 60 Nm (6 kgm/ 44.2 ft/lb).

NOTE: Put medium threadlocker (blue) on the rotor fixing thread.

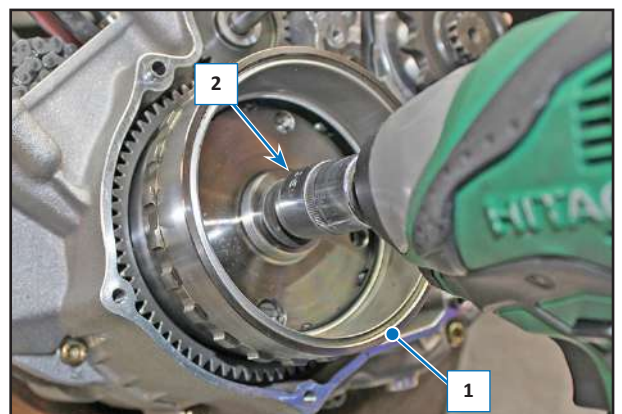

2.13 STARTER MOTOR

2.13.1 Disassembly

Remove the flywheel cover as described in the relative section.
Remove the idler (1) with the relative roller bearing cage.

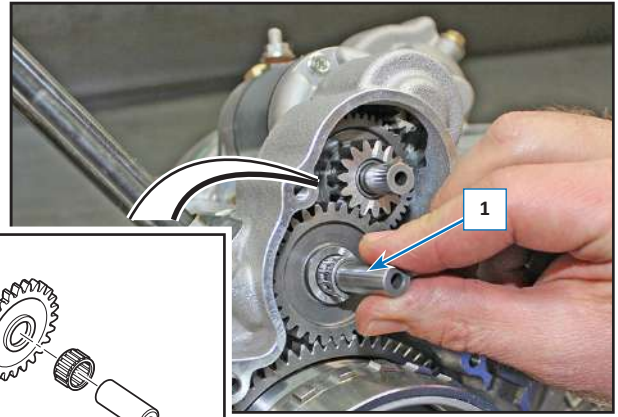
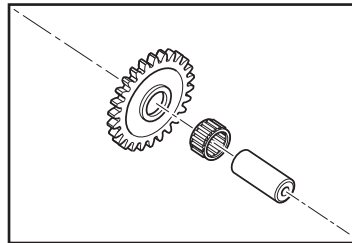

Remove the idler (2) with the relative roller bearing cages.

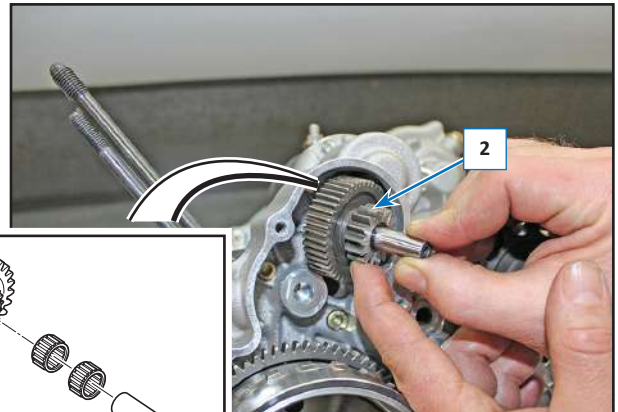
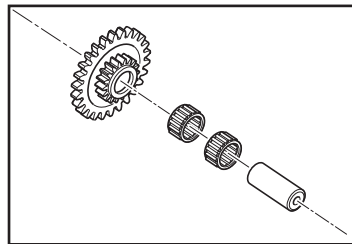

Unscrew the screw (3) and remove it with the relative washer.

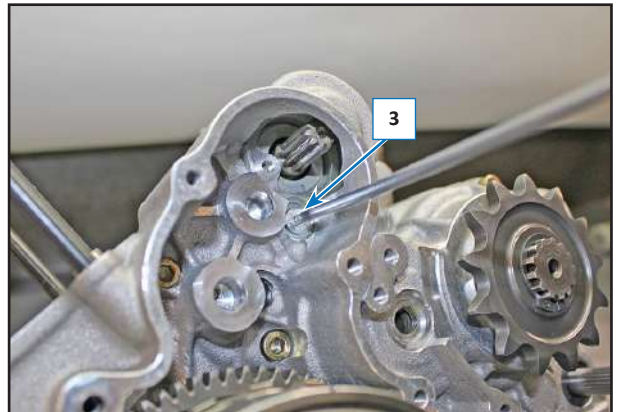

Unscrew the two starter motor fastening screws (4).

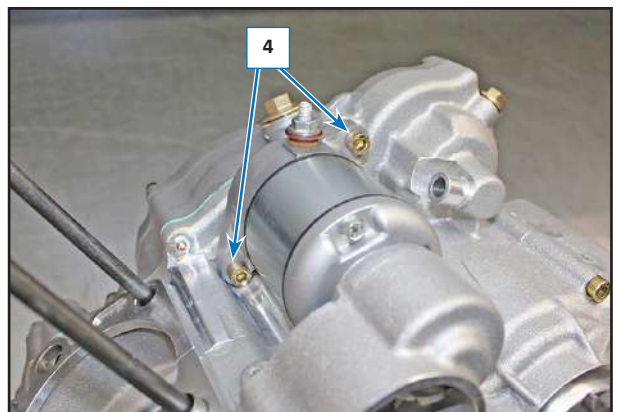

Tighten the M5 screw (5) onto the bush (6) and tighten until the bush (6) moves forward.

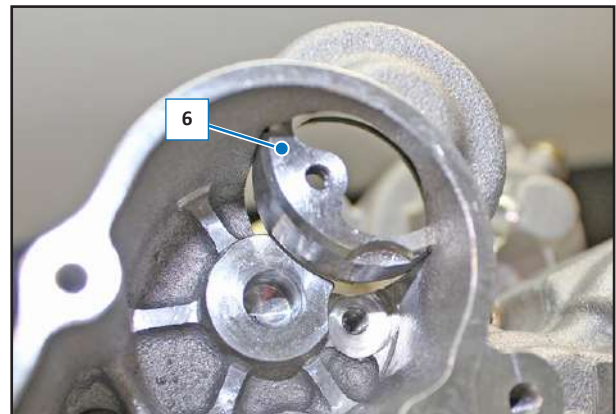
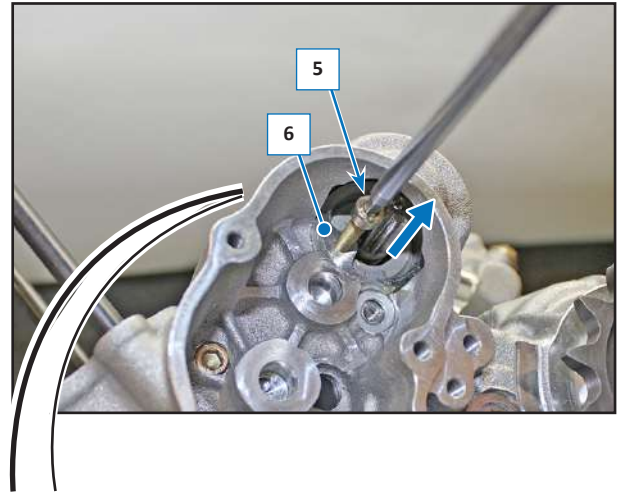

Remove the starter motor (7).

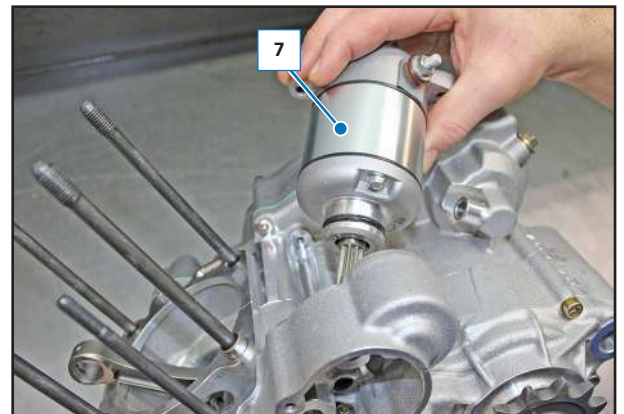

2.13.2 Re-mounting

Make sure the "OR" gaskets (8) are not ruined and, if so, replace them.



Check the status of the "OR" gasket (9) positioned on the starter motor (7); replace it if ruined.

Lubricate the gasket (9) and the gaskets (8) with engine oil and then mount the starter motor (7).

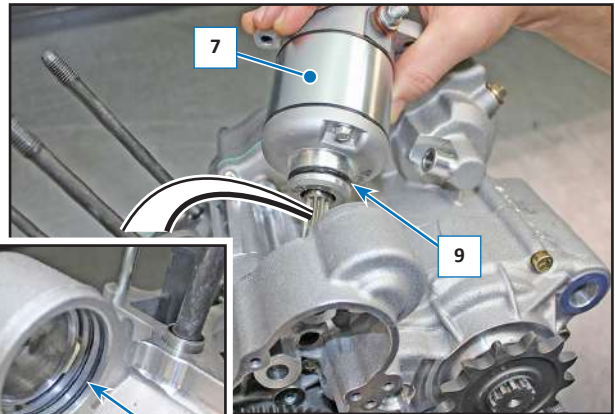

Use an aluminium or brass punch to push the bush (6) towards the inside of the engine, making the milled part coincide (6a) with the screw housing (6b).

NOTE: If the bush (6) is forced, grease abundantly.

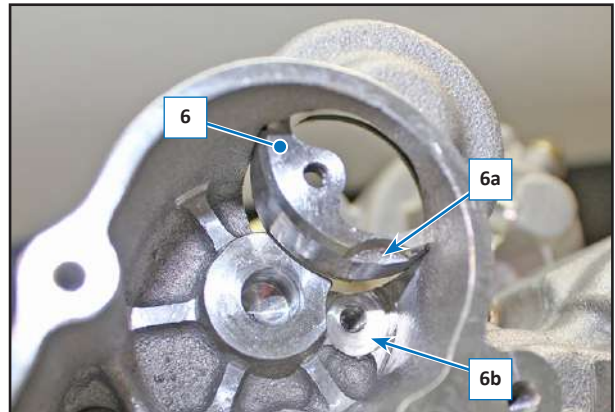

Tighten the screw (3) with relative washer to a torque value of 6 Nm (0.6 Kgm - 4.42 ft/lb) + Loxeal 82-33.

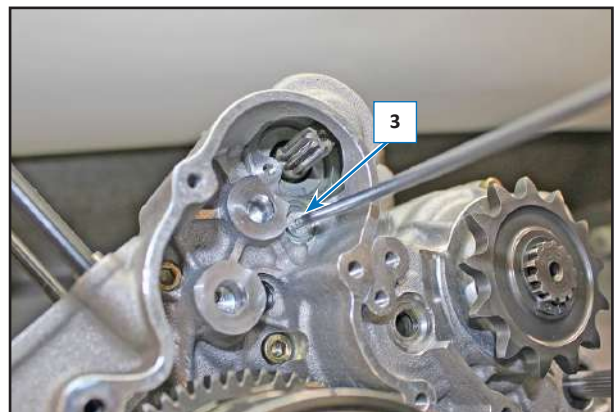

Re-mount the idler (2) with the relative roller bearing cages and lubricating with engine oil.

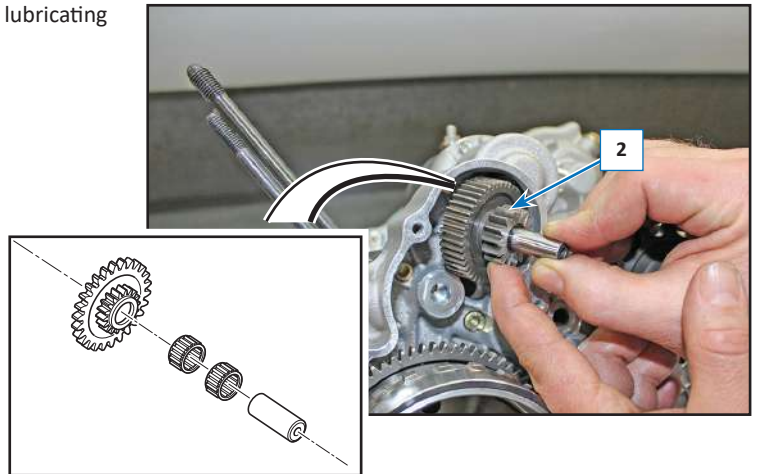

Re-mount the idler (1) with the relative roller bearing cage and lubricating with engine oil.

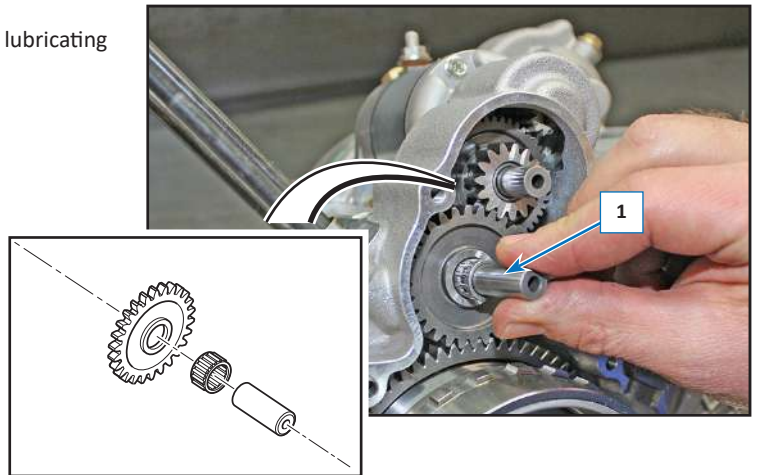

2.14 WATER PUMP

NOTE: If water escapes from the little hole (1), the pump seal must be replaced.

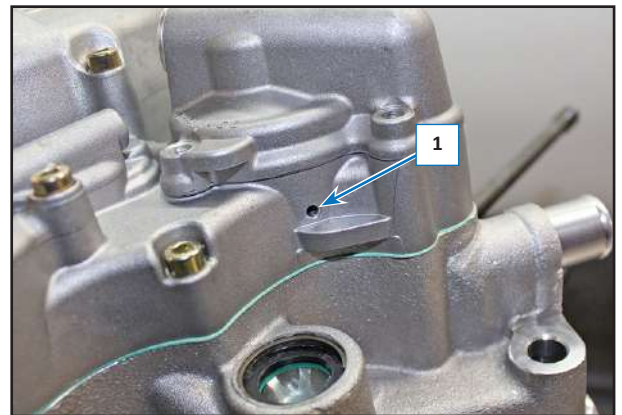

Loosen the screws (2) and (2a) M5-L20, screw (3) M5-L45 and screw (4) M5-L50.

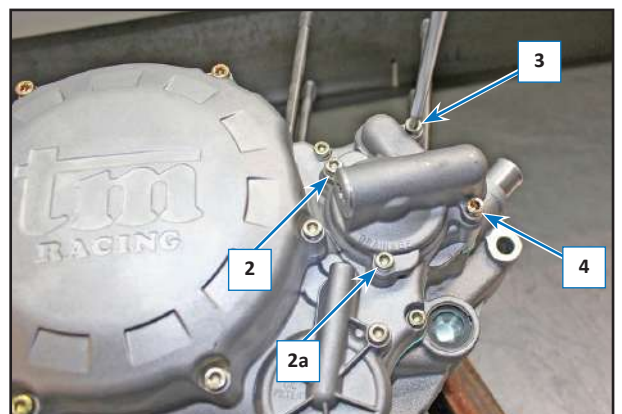

Remove the cover (5) with the relative gasket (6).

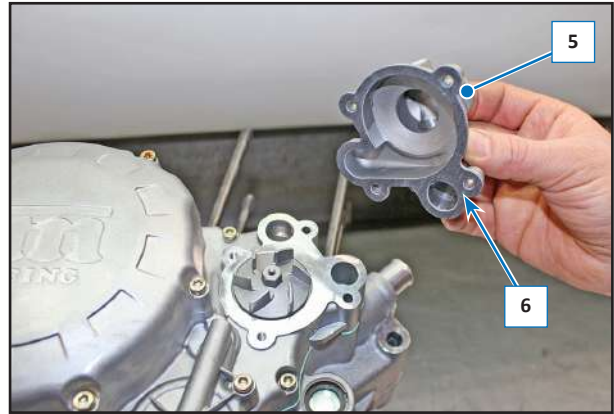

Insert a "T"-shaped wrench (7) through the flywheel cover to block crankshaft rotation.

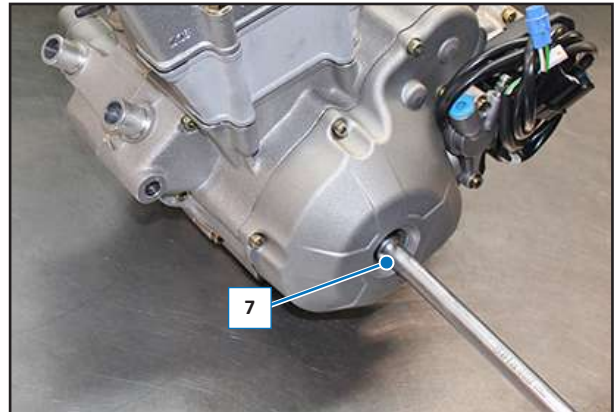

Loosen the pump impeller (8).



Use a screwdriver to remove the seal (9).

NOTE: Lubricate the seal (9) with engine oil before mounting it.

Re-mount the impeller (8) tightening with a torque of 6 Nm (0.6 kgm/ 4.42 ft/lb), greasing the thread.

Re-mount the pump cover (5) checking that the gasket (6) is not ruined; replace it if necessary.

Tighten the screws (2), (3), (4) with a torque of 8 Nm (0.8 kgm/ 5.9 ft/lb), replacing the aluminium washer of the screw (2a).

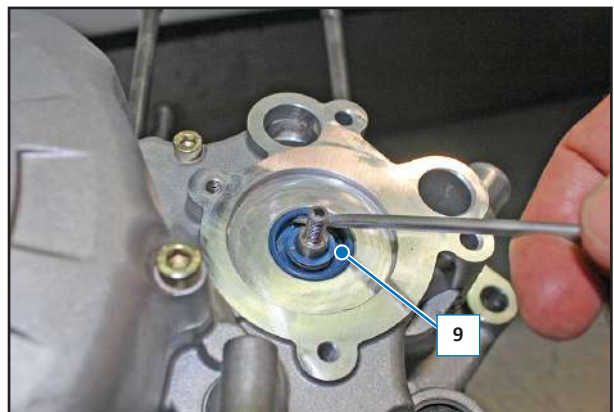

2.15 TRANSMISSION GUARD

Unscrew the screws (1):

- 1a) M5-L25 screw
- 1b) M5-L30 screw
- 1c) M5-L65 screw
- 1d) M5-L45 screw
- 1e) M5-L50 screw

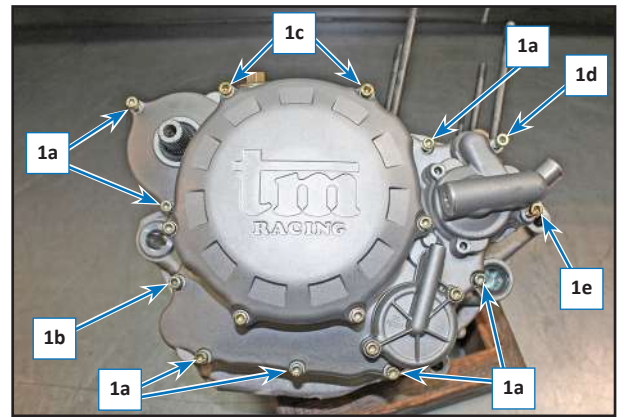

Remove the guard (2), with the aid of a rubber hammer.



Remove the gasket (3) and recover the two centring bushes (4).

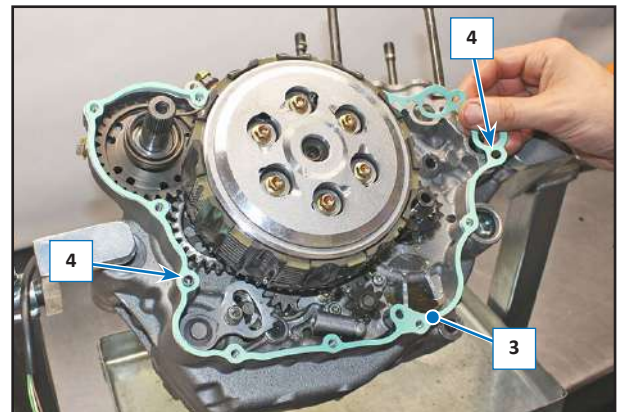

Remove the water pump return (5).

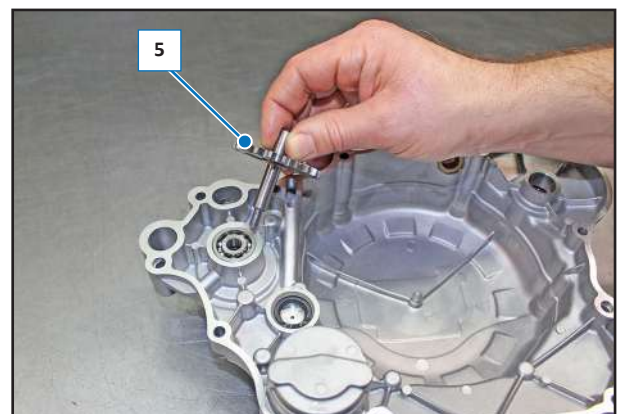

2.15.1 Bearing and water pump oil seal removal

Heat the bearing to a temperature of 50°C and remove the bearing (6).

WARNING: Use suitable personal protection equipment;
Burns hazard.

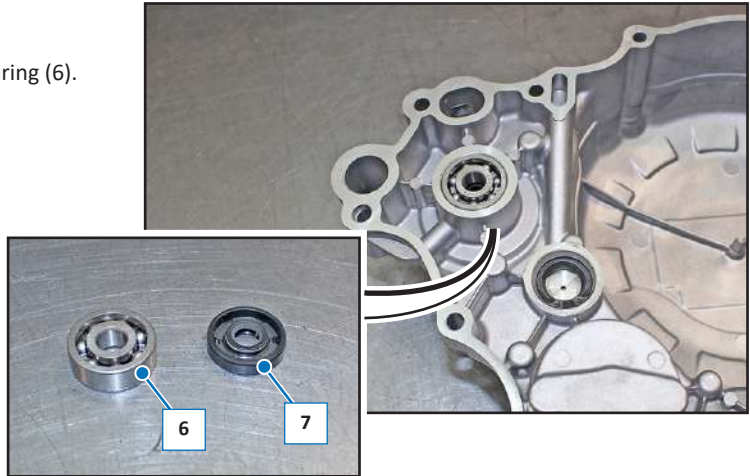

Remove the oil seal (7), operating from the external part of the guard with water pump disassembled.

NOTE: On re-mounting, first mount the bearing (6) and then the seal (7), lubricating it with engine oil.

2.15.2 Seal and oil passage bored disc removal

Remove the seeger (8), the seal (9) and the bored disc (10).

Check that the little hole in the bored disc (10) has not been clogged. If this is the case, clean it and re-mount everything in reverse order to disassembly and replace the seal (9).

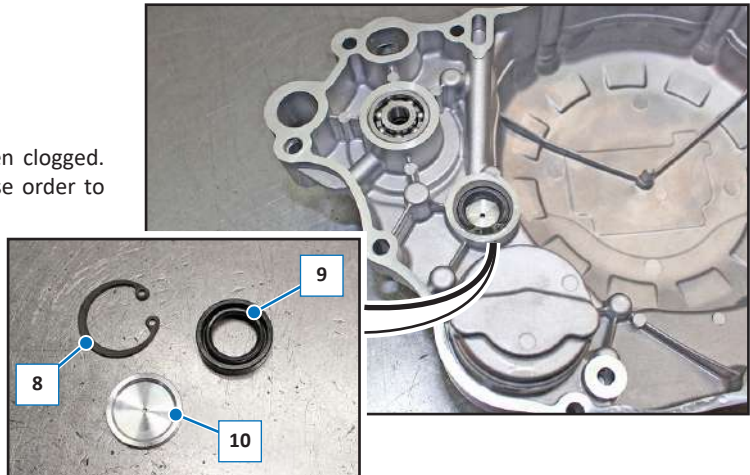
2.15.3 Kick start seal removal

Use a screwdriver to remove the seal (11) and replace it.



2.15.4 Transmission cover re-assembly

Clean the surface of the lid and the semicase from any residues.

Check that the two centring bushes (4) are in their respective housing.



Replace and re-mount the gasket (3).

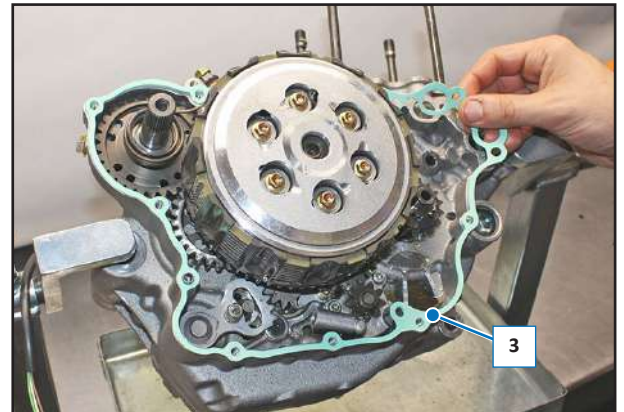

Mount the water pump return (2) on the cover (5).

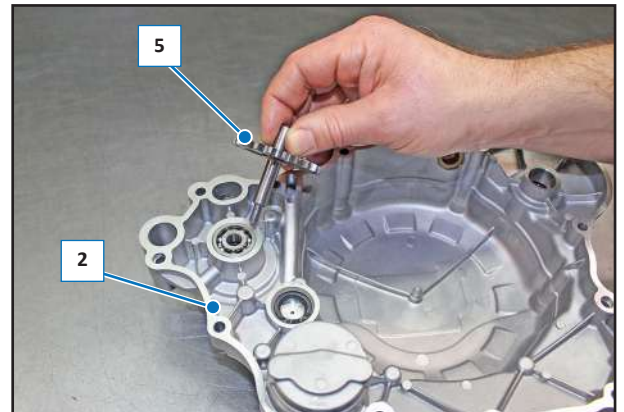

Mount the cover (2), centring it on the bushes (4), paying attention not to ruin the seals.



Tighten the screws (1) crosswise, positioning them in the relative housing, depending on their length.

- 1a) M5-L25 screw
- 1b) M5-L30 screw
- 1c) M5-L65 screw
- 1d) M5-L45 screw
- 1e) M5-L50 screw

First screw without tightening with a torque of 8 Nm (0.8 kgm/ 5.9 ft/lb).

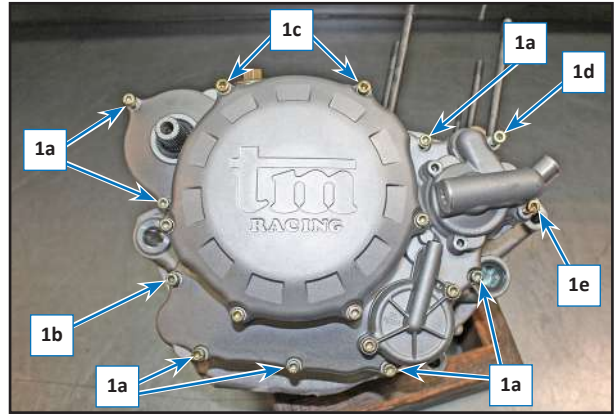

2.16 IDLE KICK STARTER REMOVAL (ONLY K.S.)

Remove the transmission cover and the clutch bell as described in the relative paragraphs.

Release the spring (1) from the relative housing, turn the starter (2) anti-clockwise by 1/4 of a turn.

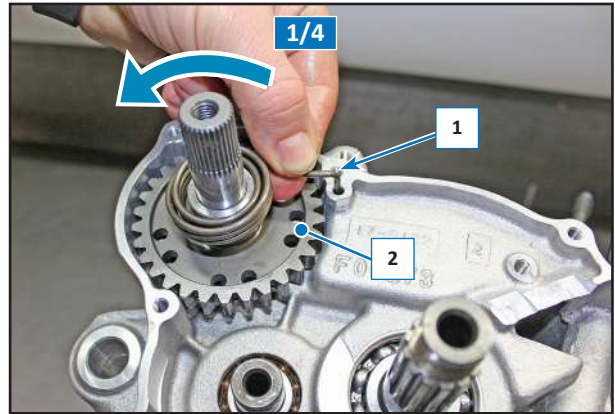

Remove the starter (2) complete with spring (3) and washer (4).

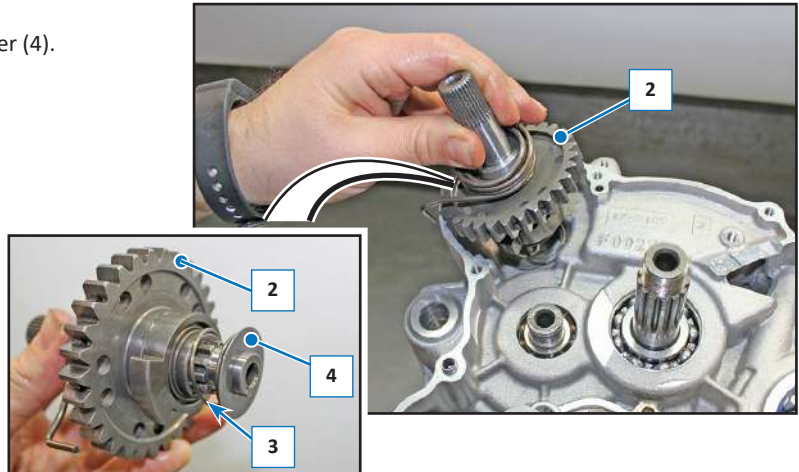

2.16.1 Starter dismantling

In sequence, remove the washer (4), spring (3), bush and ratchets (5), the seeger (6), shim (7), gear (8), shaft (9), bush (10) and the spring (1).

Re-assemble in reverse order to dismantling, paying attention to positioning the pin (11) of the spring (1) in the relative hole (12) on the shaft (9).

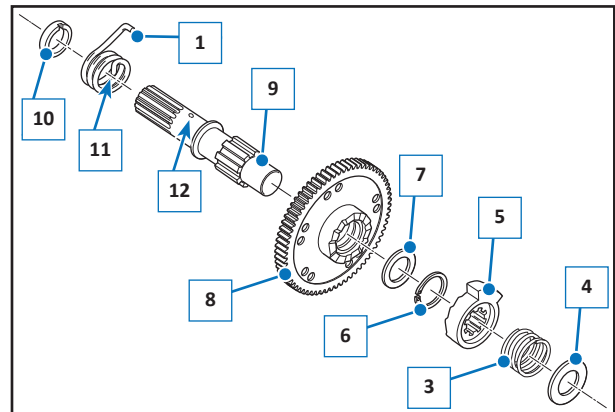

2.16.2 Re-mounting

Re-mount the idle kick start in the relative housing and then turn the starter (2) clockwise by 1/4 of a turn and insert the pin (1) in the hole in the guard.

NOTE: Lubricate the fitting hole abundantly with graphite grease.

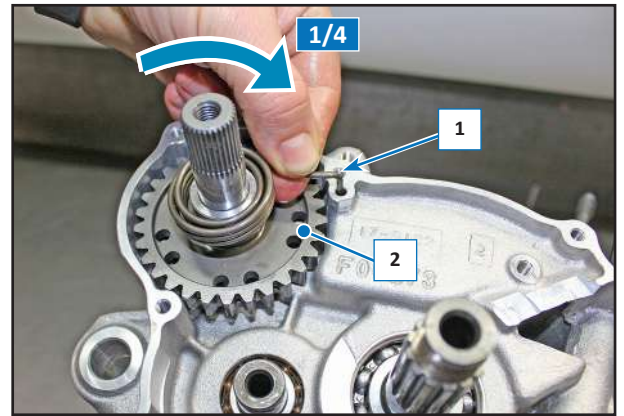

2.17 DRUM AND CLUTCH BELL

2.17.1 Disassembly

Remove the transmission cover as described in the relative paragraph.

Remove the clutch discs as described in the relative paragraph.

Remove the clutch mushroom (1), con un punzone aprire la rondella di sicurezza (2).

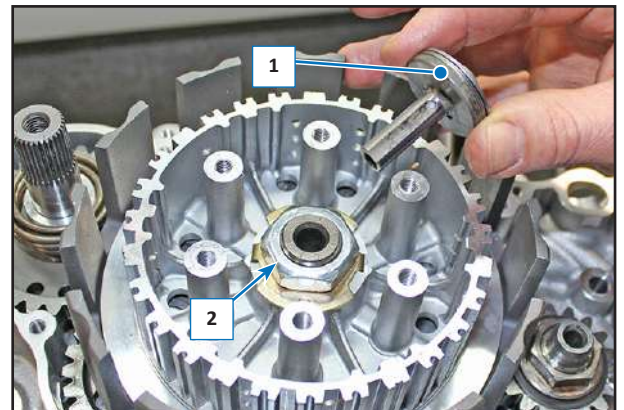

Use a spanner to block rotation of the clutch drum (3) and tighten the nut (4).

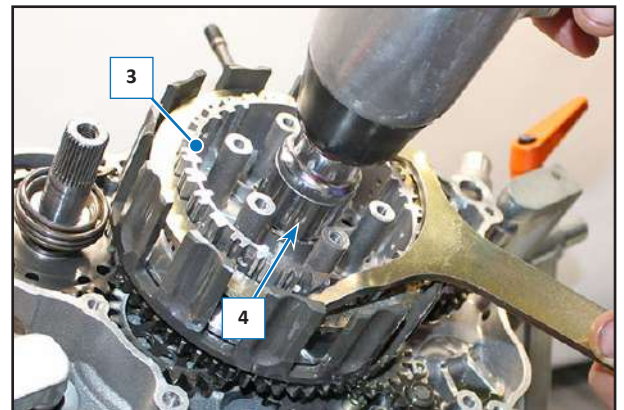

Remove the safety washer (2).

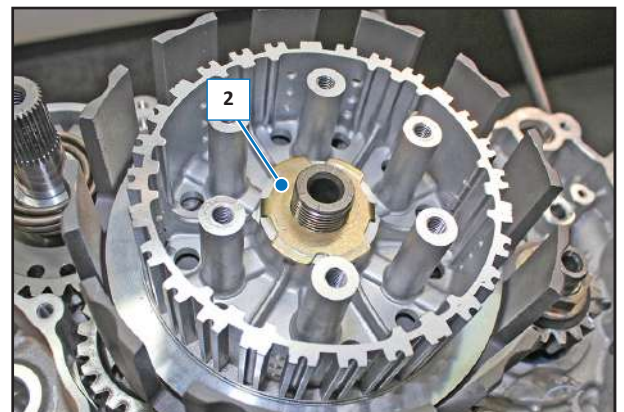

Remove the drum (3).

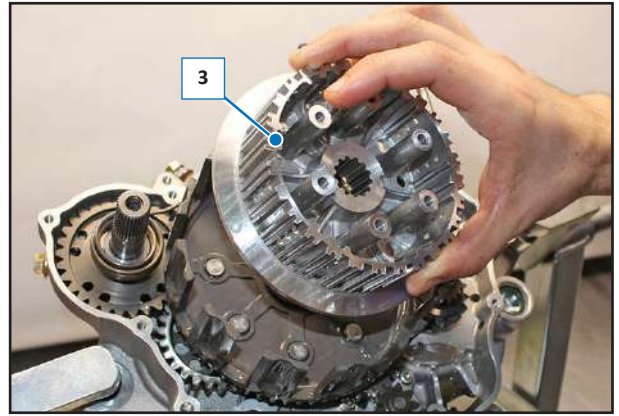

Remove the washer (5).

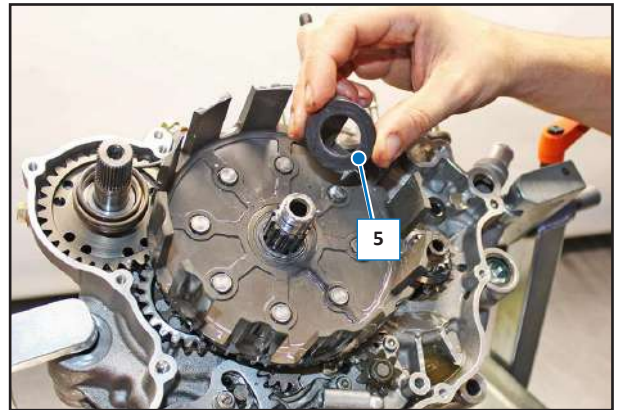

Remove the bell (6).

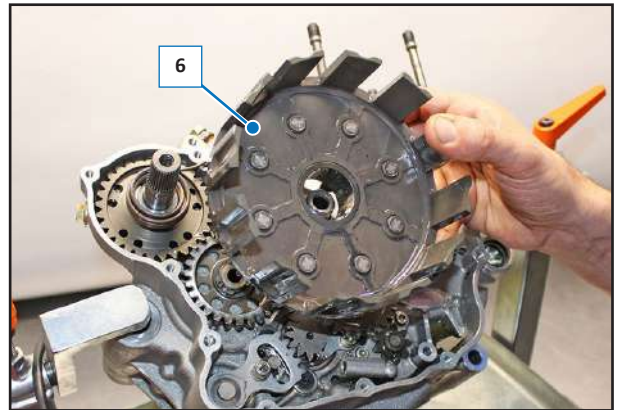

Remove the two roller bearings (7) and the spacer (8).

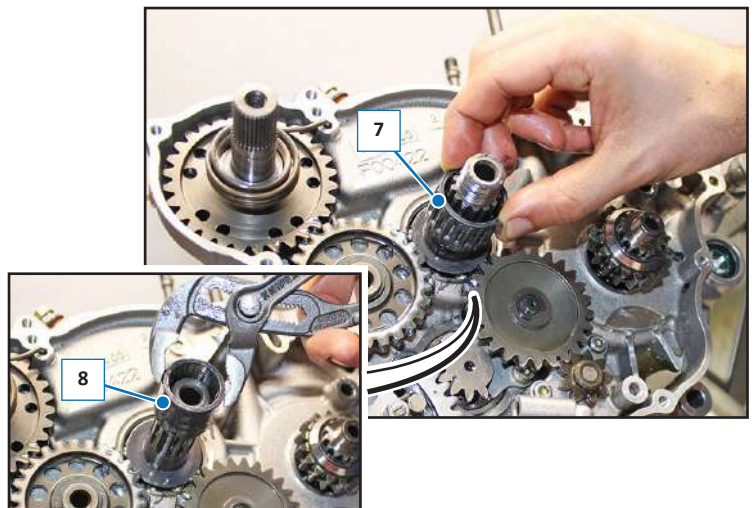

Remove the washer (9).

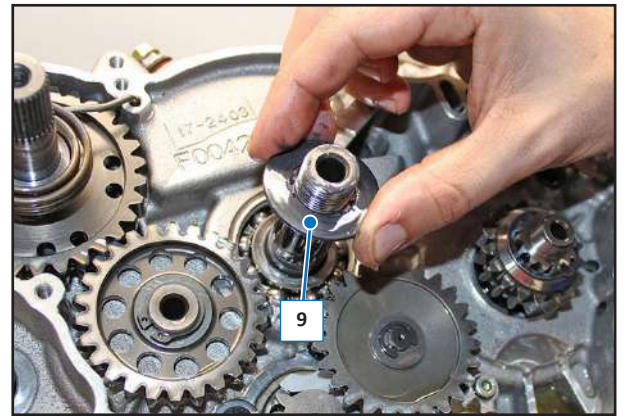

2.17.2 Re-mounting

Insert the washer (9).

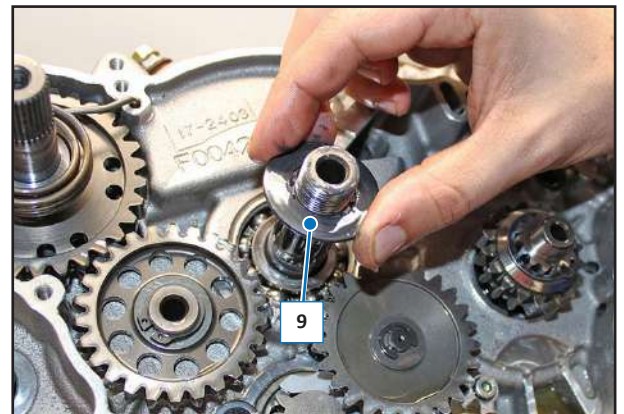

Re-mount everything, proceeding in the reverse order to disassembly.

Make sure that the spacer (8) and ball bearings cage (7) are re-mounted correctly and lubricate them with engine oil.

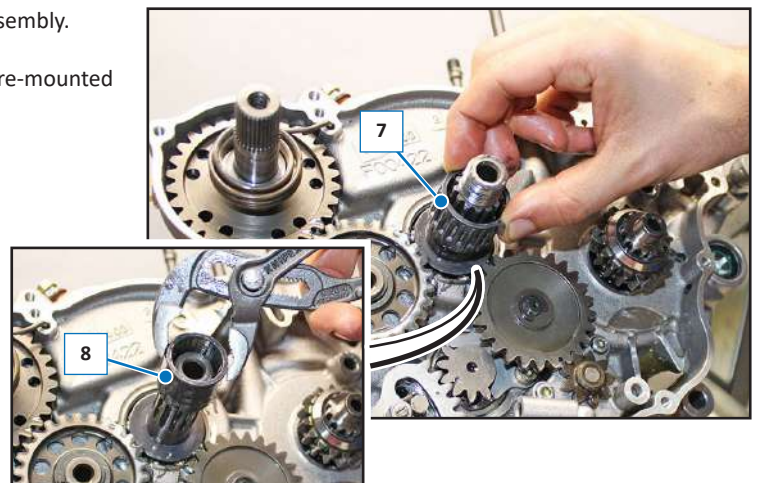

Proceed exactly with the reverse procedure.

Re-mount the bell (6).

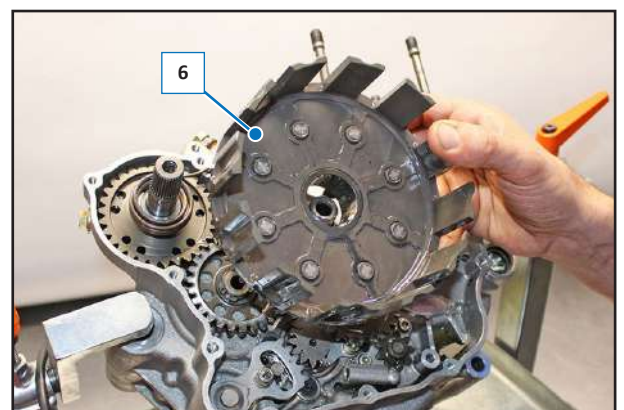

Insert the washer (5).

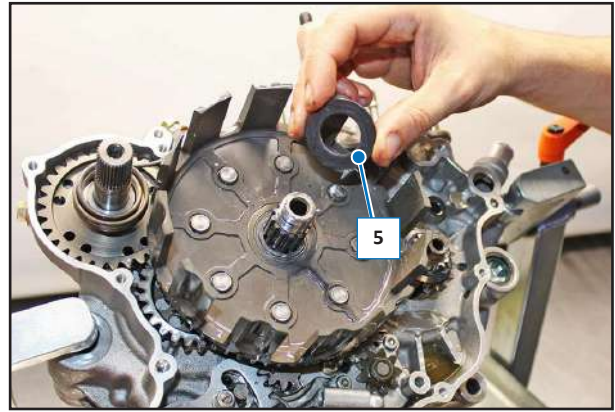

After having re-mounted the bell (6) and the drum (3), make sure the safety washer (2) has been positioned correctly.

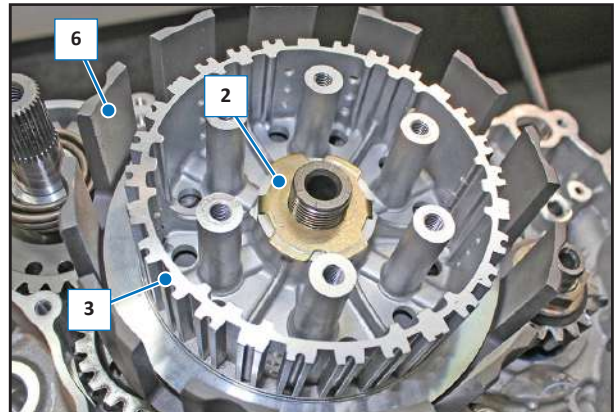

Screw the nut (4), blocking drum rotation with a spanner, with torque of 100 Nm 10.0 kgm 73.75 ft/lb + strong threadlocker (green).

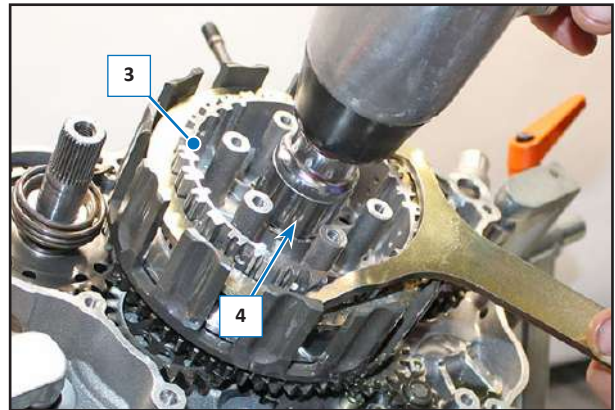

Lock the nut by raising the tabs of the lock washer (2).

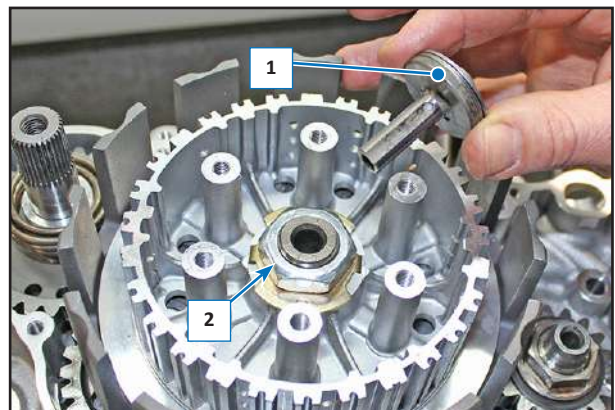

2.18 TRANSMISSION SIDE COUNTER GEARS

Components layout:

- 1) Oil pump return gear.
- 2) Idle gear kick starter removal.
- 3) Kick starter (only for K.S.).
- 4) Gearbox primary shaft.
- 5) Gearbox command shaft.
- 6) Ratchet-holder gear.
- 7) Oil pump.
- 8) Crankshaft gear.

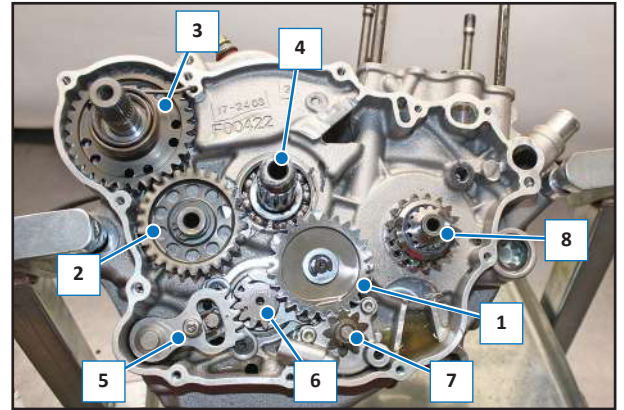

Remove the seeger (9) and the washer (10).

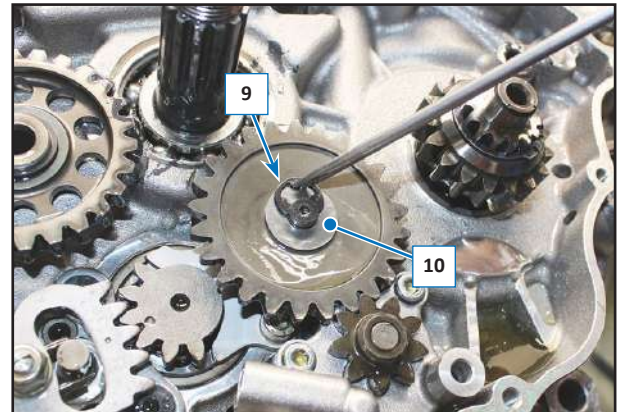

Remove the oil pump return gear (1).

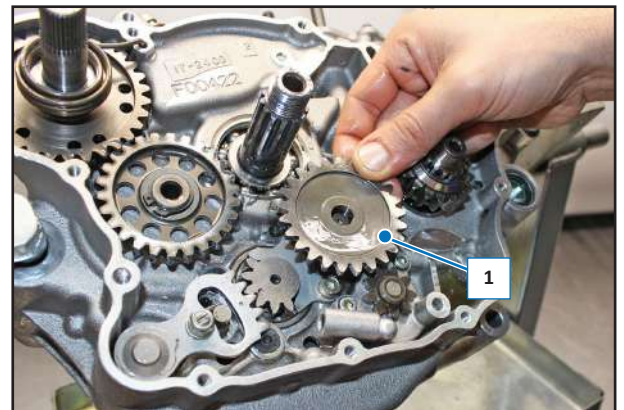

Remove the roller bearing cage (11) and the washer (12).

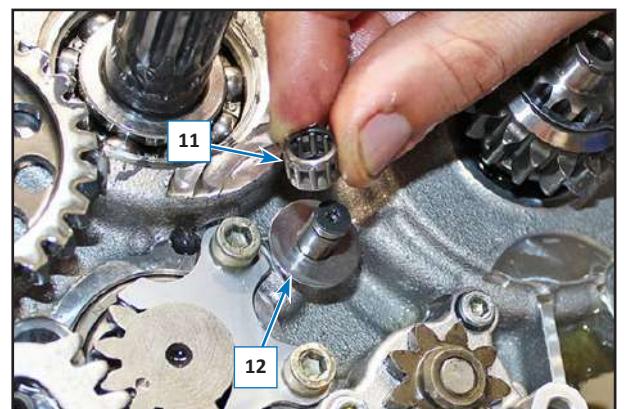

Remove the seeger (13).

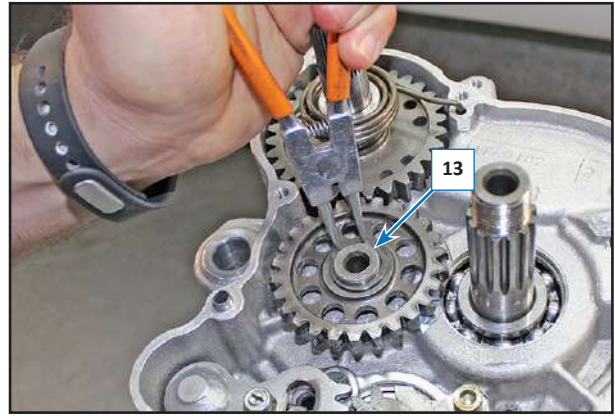

Remove the shim (14) and the gear (2).

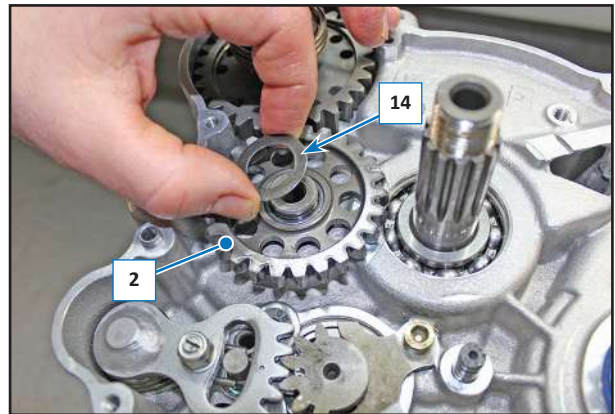

Remove the roller bearing cage (15) and the shim (16).

NOTE: To re-mount the gears and relative roller bearing cages, proceed in reverse order to disassembly and lubricate with engine oil.

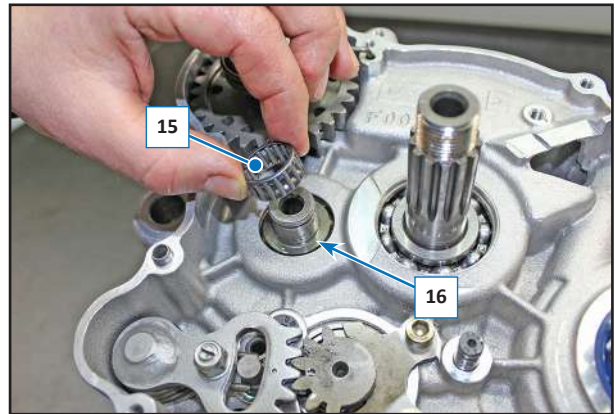

2.19 CRANKSHAFT GEAR REMOVAL

Remove the seeger (1).

Remove the gear (2).

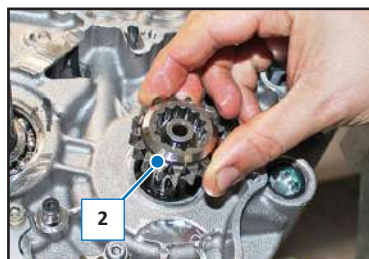
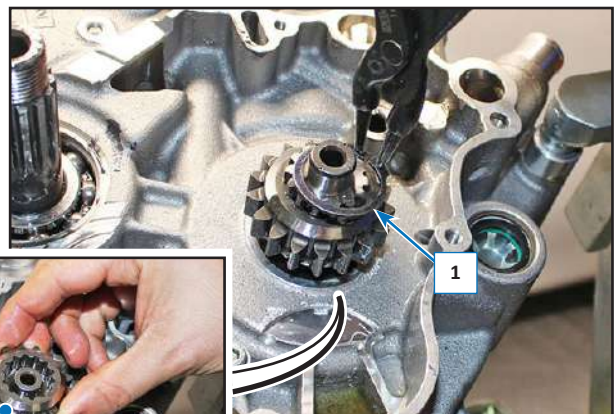

2.20 OIL PUMP REMOVAL

Remove the clutch bell and the oil pump return gear, as described in the relevant paragraphs.

Unscrew the screws (1).

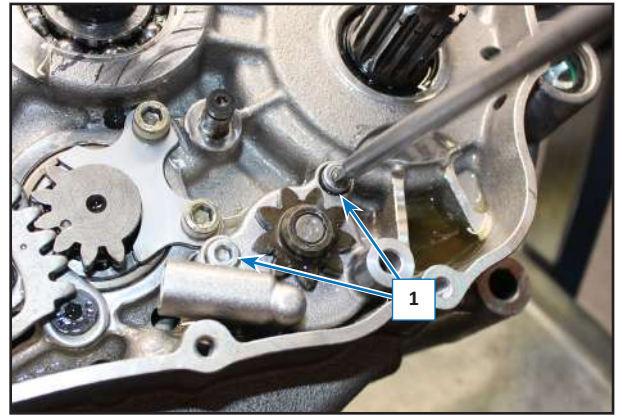

Remove the pump (2) by lifting it.

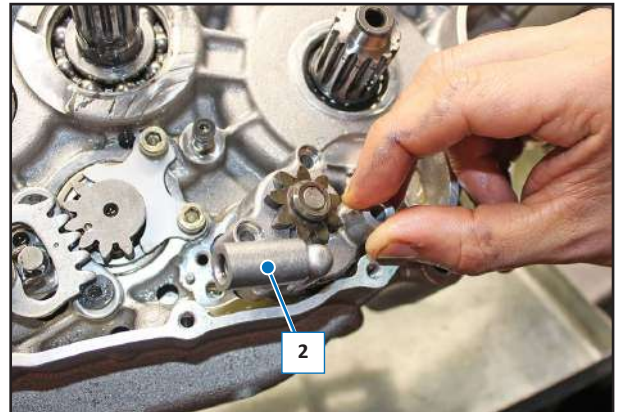

Remove the two centring pins (3).

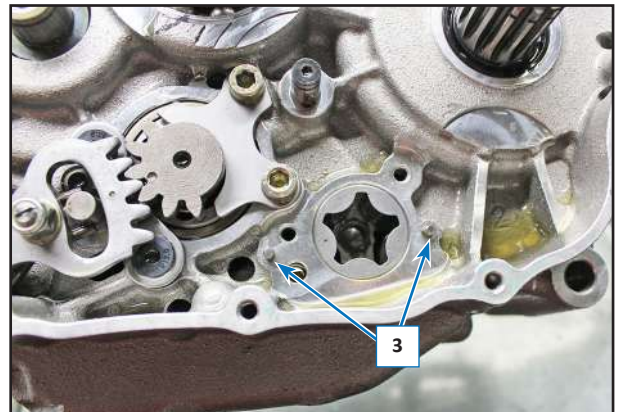

Remove the two external selectors (4).

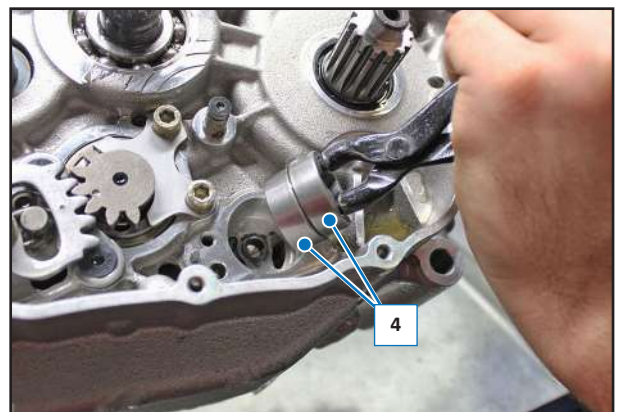

Remove the internal rotor (5)

Remove the pin (6) and the rotor (7).

Remove the pin (8).

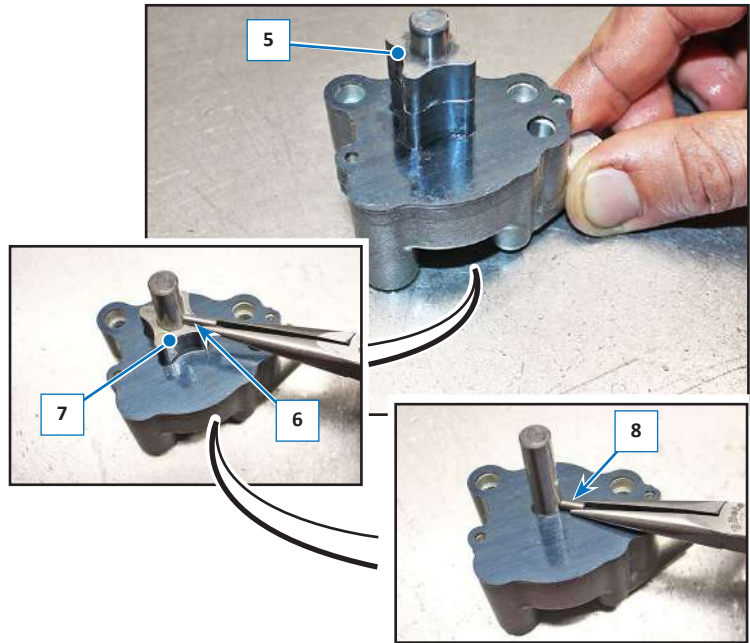

Remove the separation plate (9).

Remove the two internal sectors (10), (11) and the dragging pin.

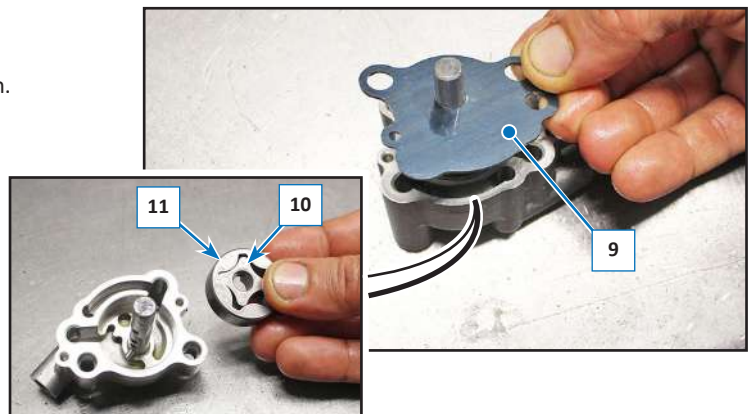

Extract the shaft (12) by pushing it.

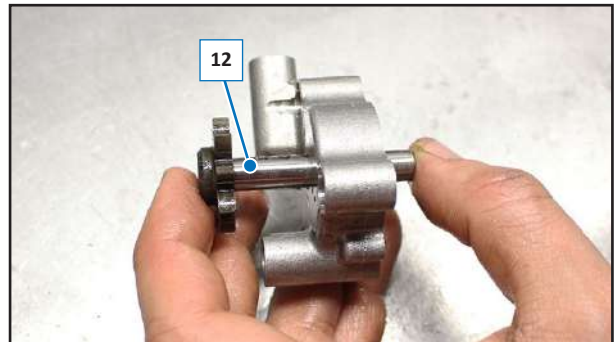

Remove the seeger (13), the washer (14) and remove the spring (15) of the oil maximum pressure valve.

NOTE: On re-mounting, lubricate with engine oil and check that the dragging pins are correctly mounted and tighten the screws (1) with torque of 8 Nm (0.8 Kgm, 5.79 ft/lb).

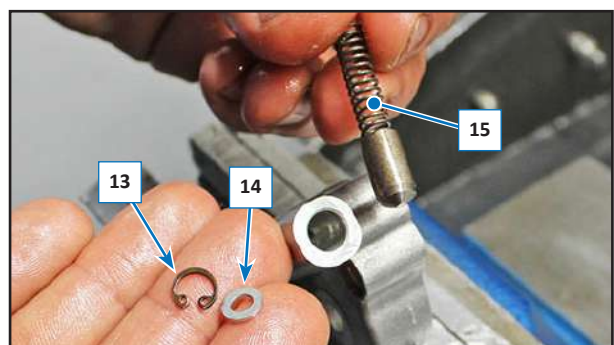

2.21 GEARBOX COMMAND SHAFT REMOVAL

Remove the transmission guard as described in the relative paragraph.

Lift the shaft (1) and extract it from the engine.

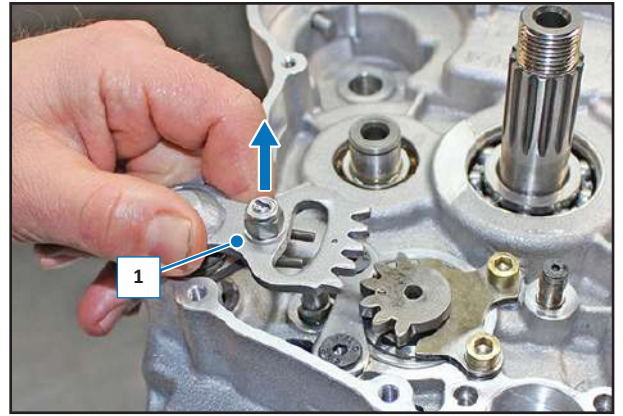

If it must be dismantled, release the spring (2) from the contrast pin (3) and remove it with the relative bush (4).

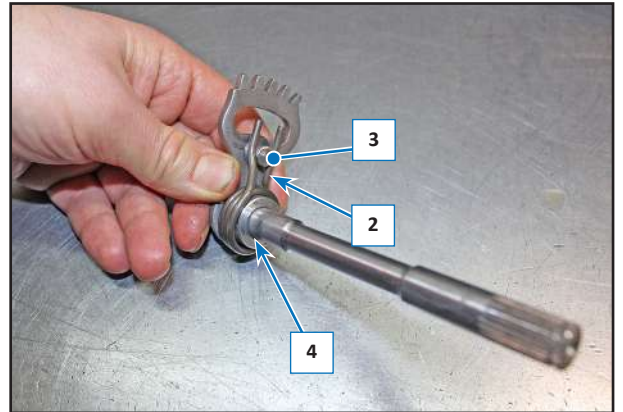

To remove the pin (3) loosen the nut (5) with relative washer (6).

NOTE: To re-mount, proceed in reverse order to the disassembly operations, paying attention that the spring (2) inserts correctly into the pin (7) fixed on the engine guard and that the two timing bolts (8), one on the shaft and the other on the ratchet-holder gear, are aligned.

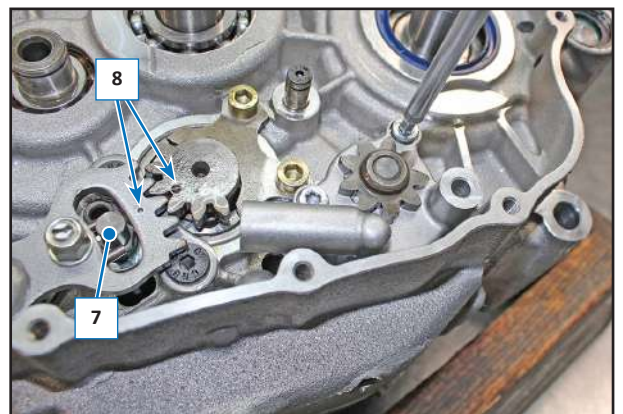
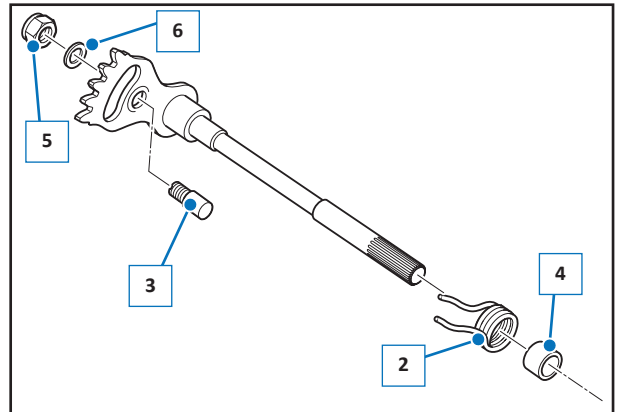

2.22 RATCHET-HOLDER GEAR REMOVAL

Remove the gearbox command shaft and the oil pump return gear, as described in the relevant paragraphs.

Unscrew the two screws (1).

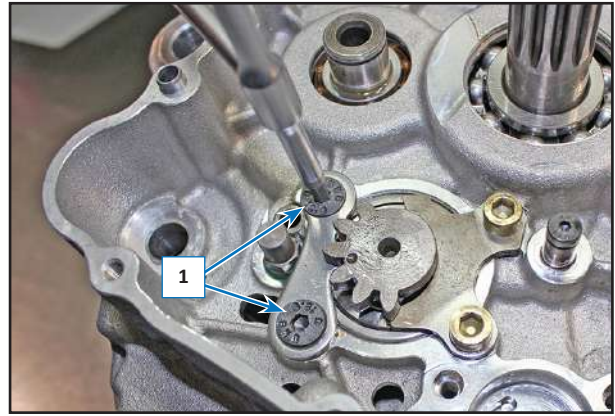

Unscrew the two screws (2).

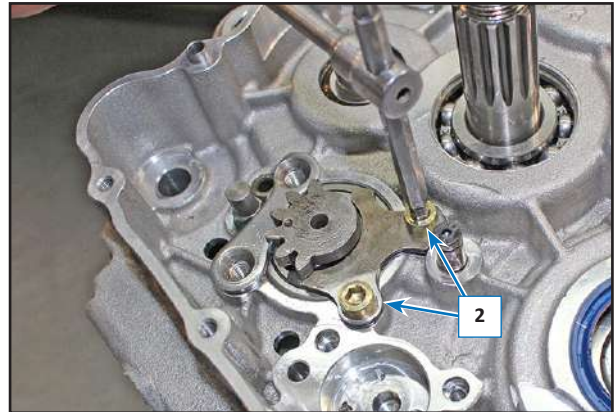

Remove the plate (3) and the plate (4).

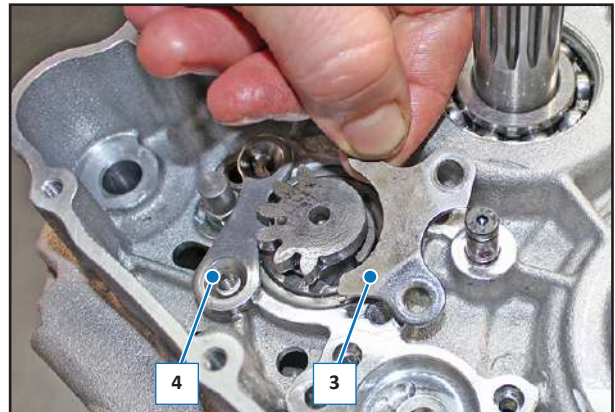

Lift and remove the Ratchet-holder gear (5).

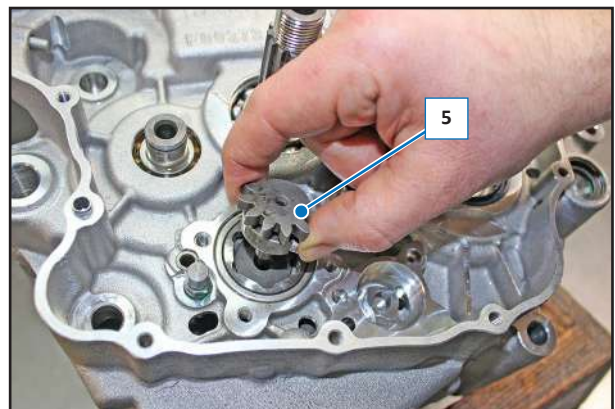

Dismantle the ratchets (6) and (7) with the relative tips (8) and springs (9).

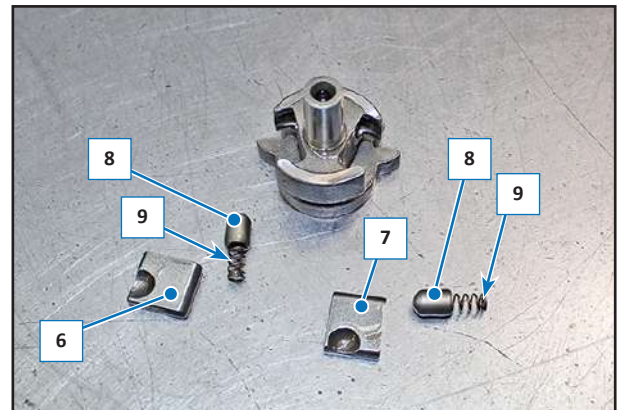
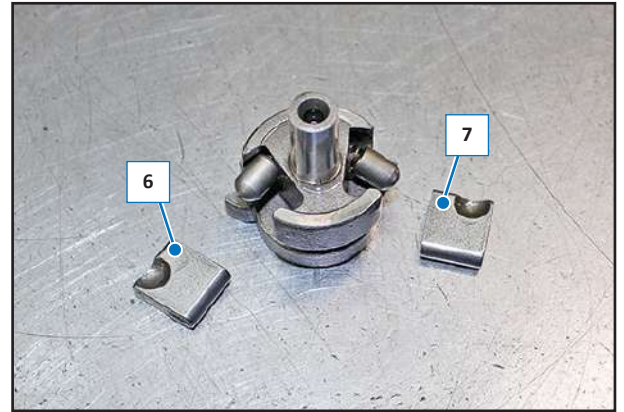

NOTE: On re-mounting, make sure the ratchets (6) and (7) are inserted correctly in the relative housing; they cannot be inverted. Re-mount everything in reverse order to the disassembly operations, checking that the two timing bolts (10), one on the shaft and the other on the ratchet-holder gear, are aligned. Tighten the screw (1) with a torque of 10 Nm (1.0 kgm, 7.37 ft/lb) and screws (2) with a torque of 10 Nm (1.0 kgm, 7.37 ft/lb) + medium threadlocker (blue).

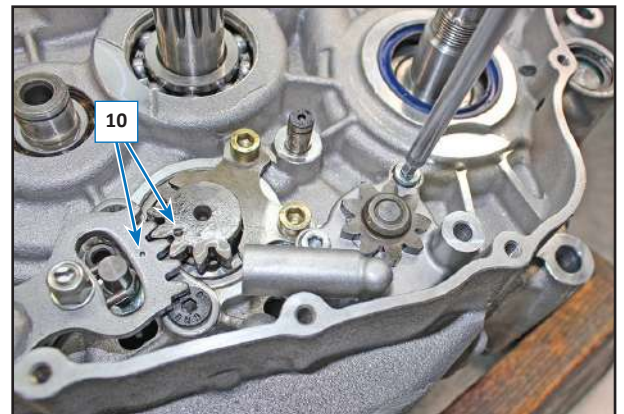

2.22.1 Ratchet holder gear and gearbox drive shaft clearance adjustment

The optimal adjustment is obtained when, with gear selected, the clearance of the ratchet holder gear (2) leftwards and rightwards is the same when the lever (1) is moved.

Work as follows for the adjustment:

Loosen the nut (3) and work on the spring cam (4) so that the condition above occurs.

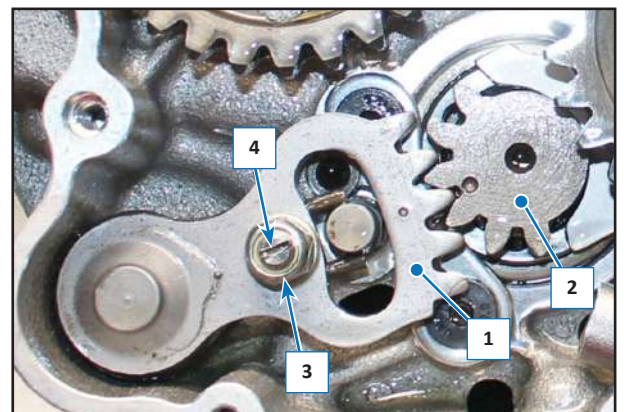

2.23 SEMICASE

Remove the heating unit as described in the relevant paragraph.

Remove all parts on the flywheel side and transmission side as described in the relative paragraphs.

2.23.1 Aperture

Unscrew the screws (1):

- 1a) M6-L55 screw
- 1b) M6-L50 screw
- 1c) M6-L35 screw

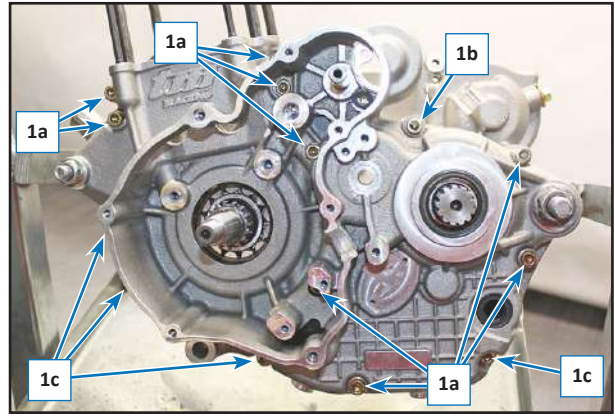

Use a rubber hammer to open the two semicases (2) and (3).

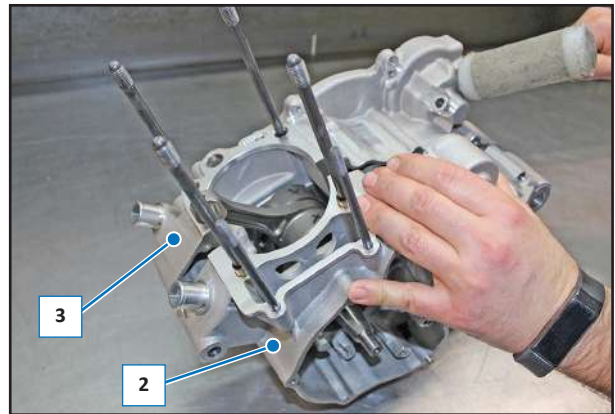

Retrieve the two bushes (4) and (5).



NOTE: There is a lamella (6) positioned on the semicase (2); loosen the screws (7) to remove it.

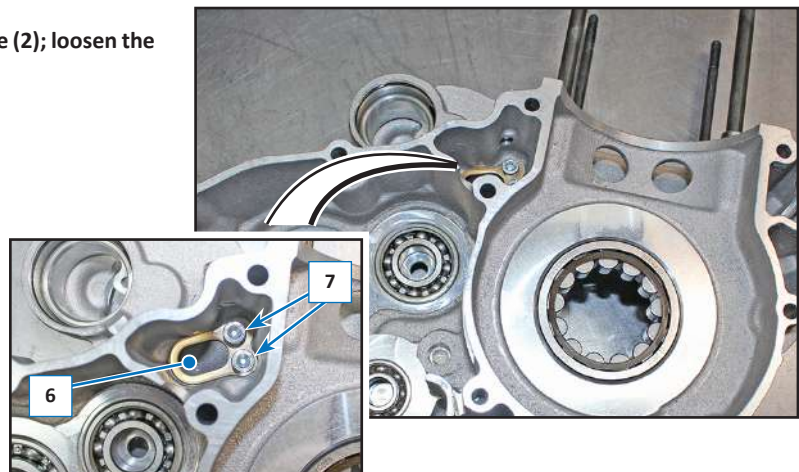

2.23.2 RE-ASSEMBLY

Check that all components are correctly positioned in their housing and that the centring bushes (4) and (5) are mounted.

Clean the contact surface from any residual sealant paste and then spread a Treebond type sealing paste.

Re-position the screws (1) in the relative housing depending on their length and tighten them with torque of 12 Nm (1.2 kgm, 8.68 ft/lb):

- 1a) M6-L55 screw
- 1b) M6-L50 screw
- 1c) M6-L35 screw

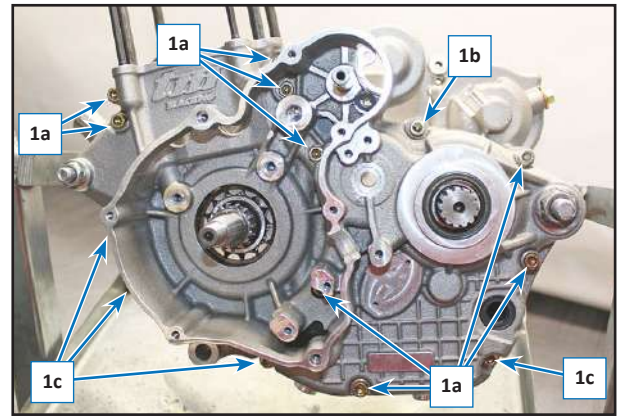

2.24 CRANKSHAFT, GEARBOX, GEARS DRUM

Open the guards as indicated in the relative section.

2.24.1 COMPONENTS POSITION

- 1) Crankshaft
- 2) Gearbox primary shaft
- 3) Gearbox secondary shaft
- 4) Gears selector drum
- 5) Ratchet
- 6) Mesh oil filters

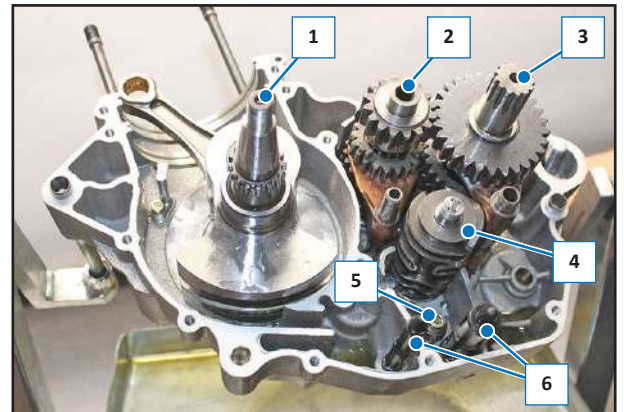

2.24.2 Oil filter removal

Lift and remove the filters (6) from the semicase; if they are very dirty or ruined, replace them on re-mounting.

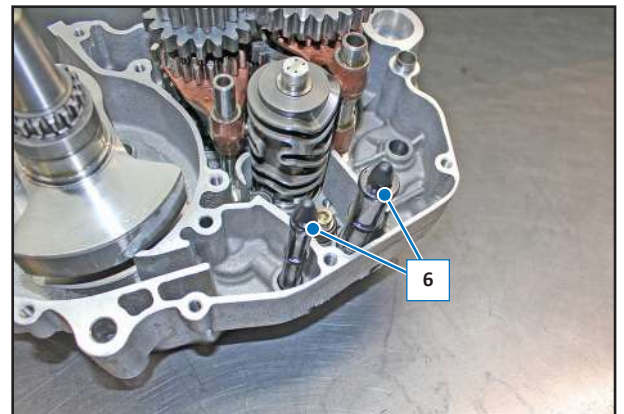

2.24.3 Crankshaft removal

Slide the complete crankshaft (1) from the semicase. If necessary, heat the bearing to facilitate removal of the crankshaft.

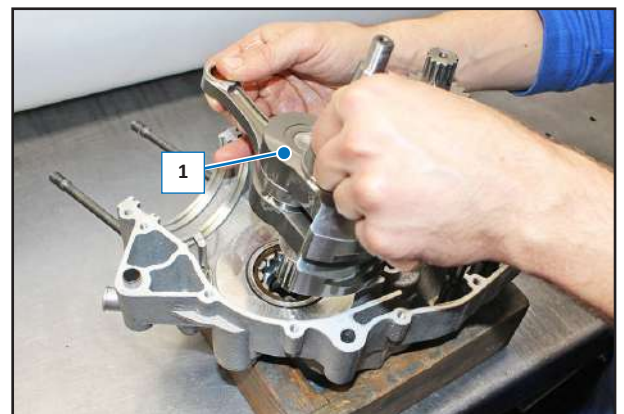

2.24.4 Gear shafts removal

Extract the secondary shaft fork pin (7).

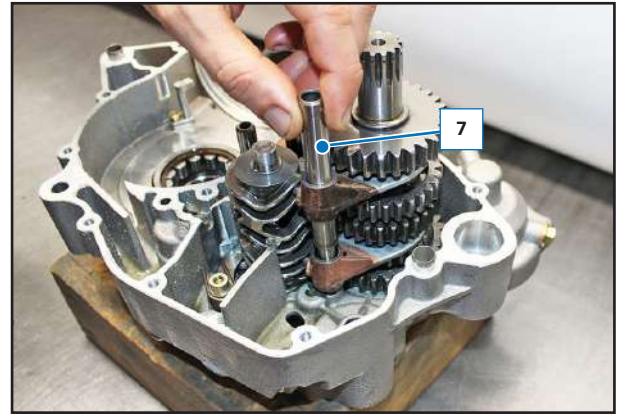

Release the forks (8) and (9) of the secondary shaft from the selector drum and remove them.

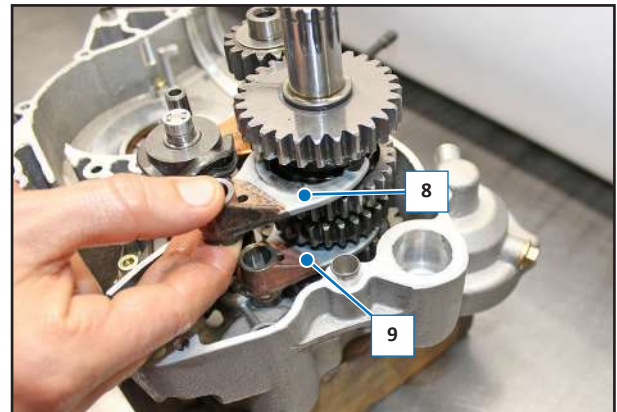

Slide the primary shaft fork pin (10) out.

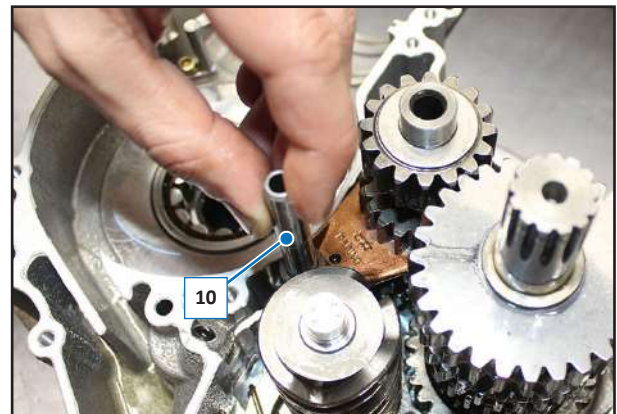

Use a screwdriver to move the ratchet (11), releasing the drum (12), and then remove the drum from the semicase.

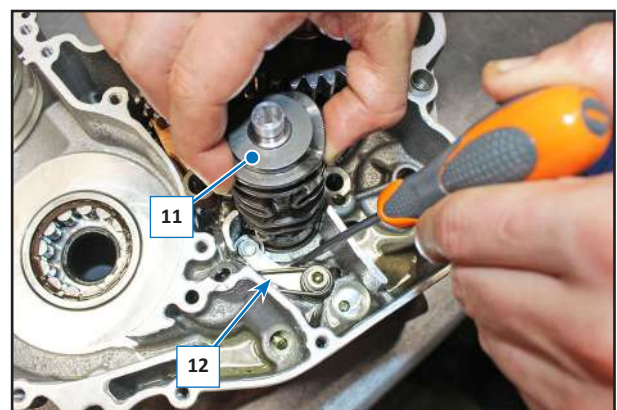

Remove the fork (13) of the primary shaft.

Remove the complete gear assy (14).

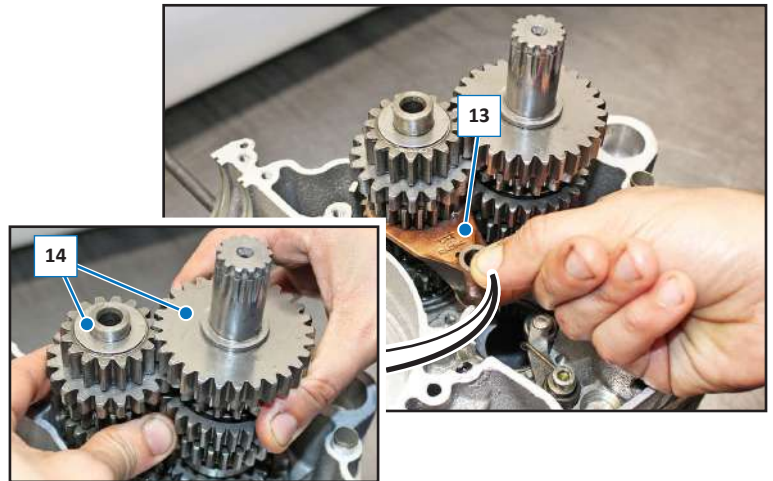

2.24.5 Primary shaft, gear sequence

- 2a) Primary shaft
- 2b) First
- 2c) Fifth
- 2d) Third
- 2e) Fourth
- 2f) Sixth
- 2g) Second

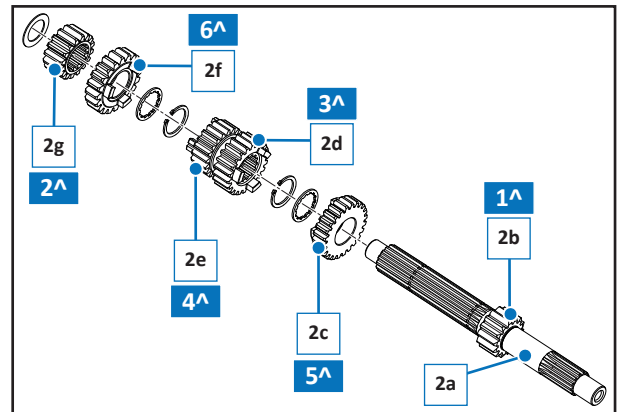

2.24.6 Secondary shaft, gear sequence

- 3a) Secondary shaft
- 3b) First
- 3c) Fifth
- 3d) Third
- 3e) Fourth
- 3f) Sixth
- 3g) Second

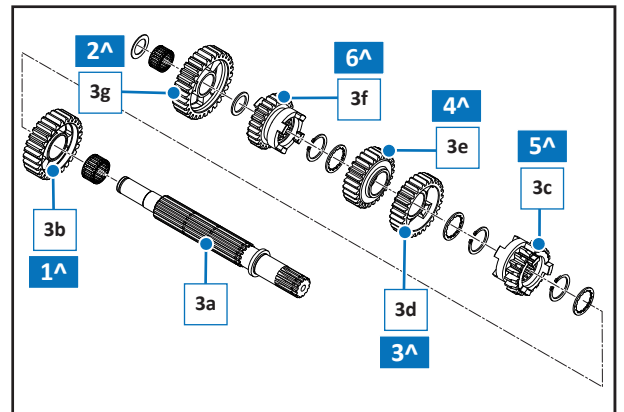

2.24.7 Ratchet removal

Unscrew the screw (15) and remove the ratchet (5) with the relative spring (16).

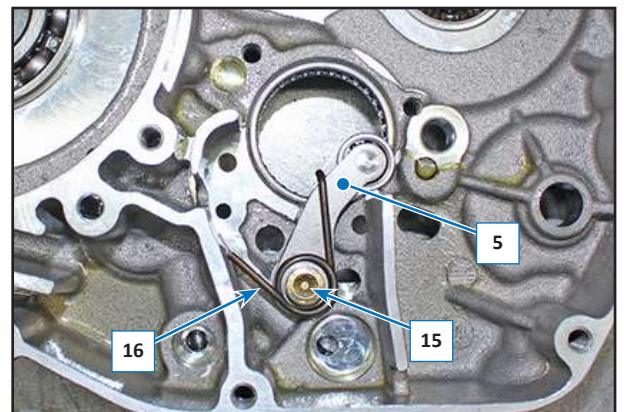

2.24.8 Bearings replacement

Unscrew the screw (1) with relative primary shaft bearing safety washer (2).

Heat the guards and remove the bearings.

NOTE: After having replaced the bearings, re-position the safety washers and tighten the screws again and applying Loxeal 82-33 on the thread.

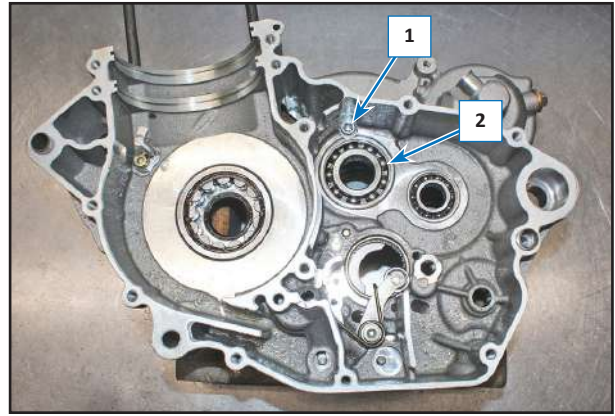

2.24.9 Components re-mounting

Re-mount the components, proceeding in reverse order to disassembly, lubricating with engine oil and, when re-mounting the gearbox unit, paying attention to correctly position the forks (7) and (10) in the relevant positions:

Fork (7) between the 5th and 3rd gear.

Fork (7a) between the 4th and 6th gear.

Fork (10) between the 3rd and 4th gear.

Check that the fork rollers are correctly inserted in the relative hollows on the drum (4).

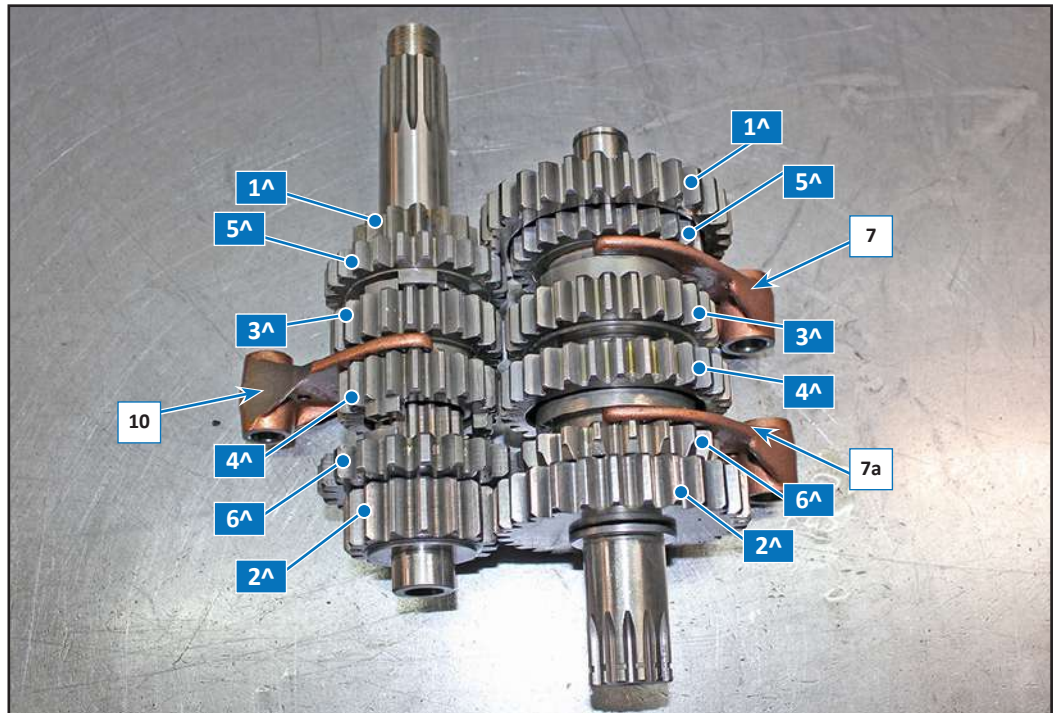
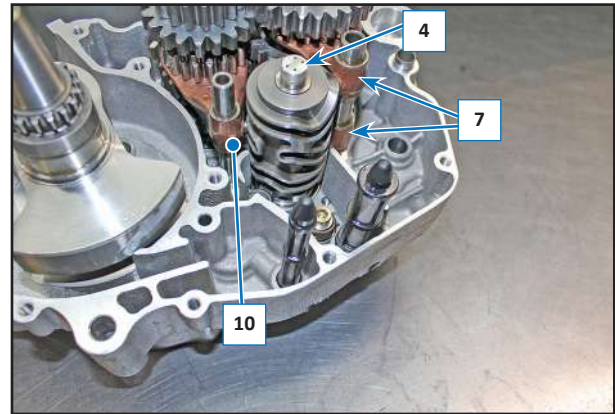

tm
RACING

